

**MagicDrill DRA**

Excellent hole accuracy with a low cutting force design

- Optimal web thickness limits deflection
- Fine chip breaking and smooth deep hole cutting
- Easy insert replacement

**NEW** Double margin type

High-precision insert  
for steel machining

**HQP**

For difficult-to-cut materials/  
stainless steel machining

**HQS**



High efficiency modular drill

# MagicDrill DRA

Excellent hole accuracy with a low cutting force design  
5 advantages to efficiently solve common drilling difficulties

4 different insert designs offer a variety of machining applications

### General purpose

**GM**

For steel/stainless steel machining  
1st recommendation

For a wide range of drilling applications  
Special chisel edge reduces thrust force and controls vibration  
Excellent hole accuracy

Drilling diameter  
ø7.94 ~ ø33

PR1535  
PR1525



**NEW**

### Double margin type

**HQP**

High-precision Insert for steel machining

Special two-step bottom and double margin  
Reduces shock for higher-precision machining of steel

Drilling diameter  
ø7.94 ~ ø19.9

PR1525



Extensive lineup of toolholders for shallow to deep hole drilling

Drilling depth	1.5D	3D	5D	8D	12D
SS-DRA Straight shank	ø7.94 ~ ø25.5				
SF-DRA Flanged shank	ø7.94 ~ ø25.5	ø7.94 ~ ø33			ø12 ~ ø25.5

Drilling diameter

Easy insert replacement



Insert can be replaced without removing screw

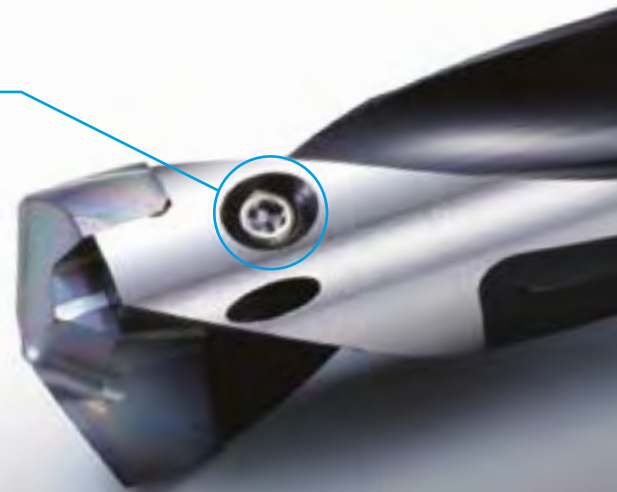

For difficult-to-cut materials/  
Stainless steel machining

# HQS

Special two-step bottom and double margin  
Improving stability of difficult-to-cut materials and  
stainless steel during machining operations



Drilling diameter  
ø8.00 ~ ø19.5

PR1535

For counterboring

# FTP

Solves problems at counterboring  
Improved hole accuracy with pilot point geometry and  
double margin specifications



Drilling diameter  
ø8.00 ~ ø25.4

PR1535

PR1525

Optimized chip thinning for  
stable chip evacuation  P3

Support groove with wider flute (5D, 8D and 12D)  
enables smooth chip evacuation



Chamfering attachment



For SS Type

# 1

## Low cutting force design improves hole accuracy

Special chisel edge with S-curve reduces thrust force and controls vibration

Cutting edge image

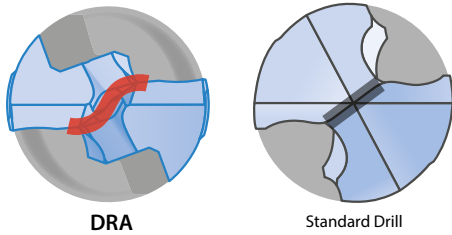

Cutting Force Comparison (Internal Evaluation)

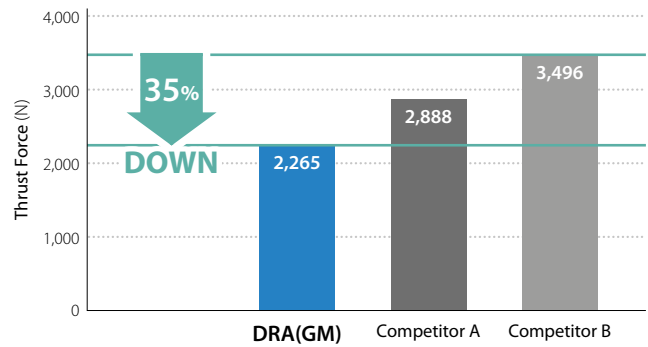

Cutting Conditions:  $V_c = 120$  m/min,  $f = 0.25$  mm/rev  
Drilling diameter  $\phi 14$ , L/D = 5, Drilling Depth 45 mm, Wet Workpiece: S50C

# 2

## Optimal web thickness limits deflection

Improved hole accuracy by controlling drill deflection with a 20% thicker web compared with Competitor C

Web Thickness Comparison

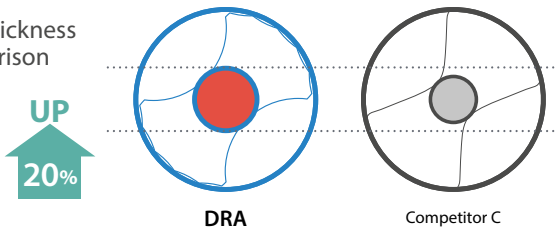

Roundness · Cylindricity comparison (Internal evaluation)

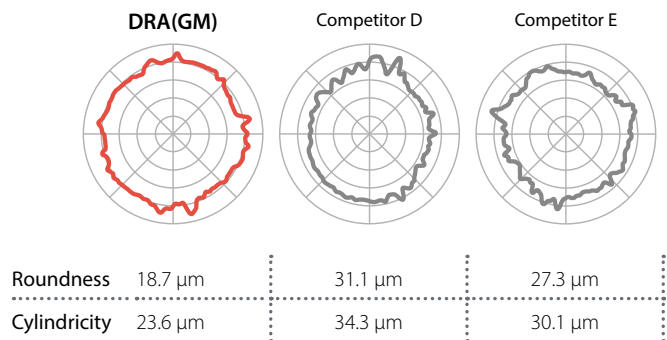

Cutting conditions:  $V_c = 120$  m/min,  $f = 0.3$  mm/rev  
Drilling diameter  $\phi 14$ , L/D = 5, Measurement position 55 mm, wet workpiece: S50C

# 3

## Fine chip breaking even in deep hole drilling applications

Optimized chip thinning for stable chip evacuation

Support groove with wider flute (5D, 8D and 12D) enables smooth chip evacuation

Chip comparison (Internal evaluation)

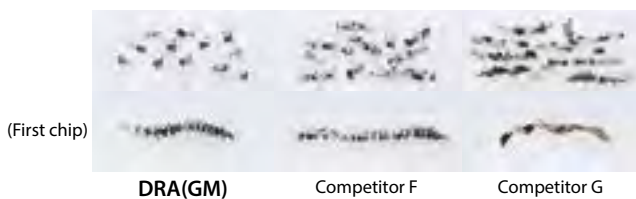

Cutting conditions:  $V_c = 60$  m/min,  $f = 0.2$  mm/rev, Drilling diameter  $\phi 14$ , L/D = 5  
Drilling depth 70 mm, wet workpiece: SUS304

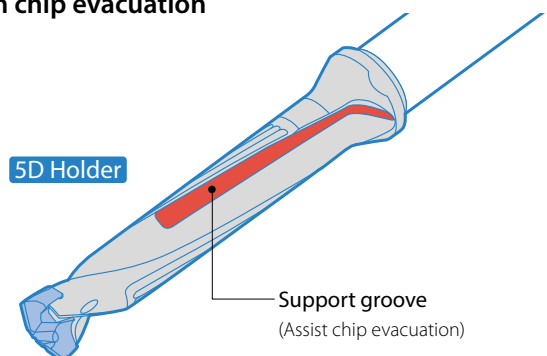

## 4 Easy insert replacement

Replace insert without removing screw

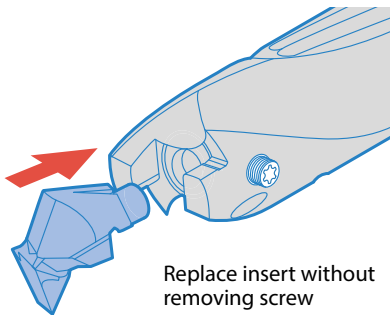

Replace insert without removing screw

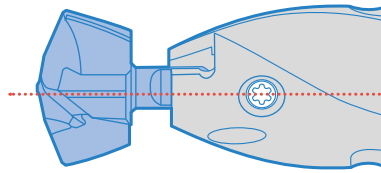

Install the insert onto toolholder (align insert guide line with screw position)

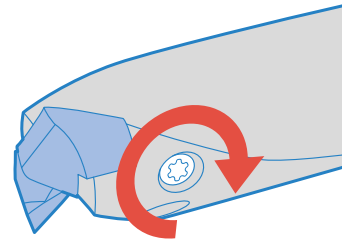

Fix the insert by tightening the screw

## 5 Long tool life and stable machining of various workpieces

MEGACOAT NANO grade PR1535 is used to machine various materials from steel to stainless steel, with the combination of a tough substrate and a special nano layer coating

1st recommendation

Steel / Stainless steel PR1535	Cast iron PR1525
-----------------------------------	---------------------

Coating properties

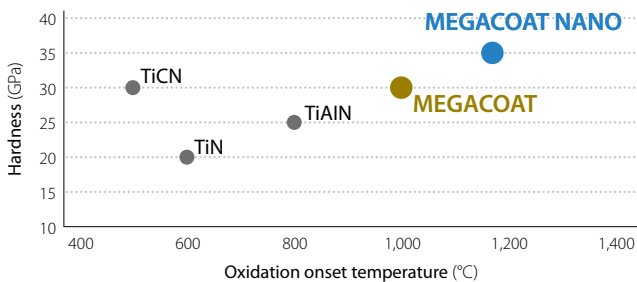

Wear resistance comparison (Internal evaluation)

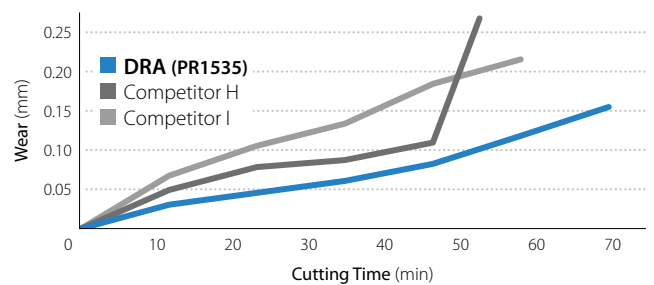

Cutting conditions:  $V_c = 100$  m/min,  $f = 0.25$  mm/rev  
Drilling dia.  $\phi 14$ , L/D = 5, Drilling Depth 45 mm, wet workpiece: SCM440H

### Case studies

#### Attachment SS400

$V_c = 70$  m/min ( $n = 1,240$  min<sup>-1</sup>)  
 $f = 0.23$  mm/rev ( $V_f = 285$  mm/min)  
Drilling Depth 100 mm  
Wet (Internal coolant)  
With center hole drilling  
SF25-DRA180M-8  
DA1800M-GM PR1535

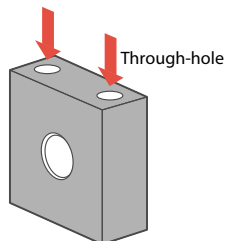

Cutting Time

DRA  $\phi 18$ -8D

45 sec

30%  
Cutting Time

Competitor J  $\phi 18$ -7D  
(Modular Drill)

65 sec

Competitor J applied a peck cycle to avoid chip clogging.  
DRA controlled chip evacuation without pecking.

(User evaluation)

#### Plate SUS304

$V_c = 60$  m/min ( $n = 2,120$  min<sup>-1</sup>)  
 $f = 0.12$  mm/rev ( $V_f = 254$  mm/min)  
Drilling Depth 15 mm  
Wet (Internal coolant)  
SS10-DRA090M-3  
DA0900M-GM PR1535

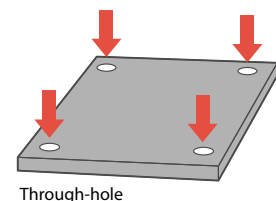

Through-hole

# of holes

DRA  $\phi 9$ -3D

500

Tool life  
5 times

Competitor K  $\phi 9$ -3D  
(Modular Drill)

100

DRA extended the tool life by 5 times compared to Competitor K.  
DRA maintained stable machining and excellent surface finish with less cutting noise.

(User evaluation)

High-precision insert for steel machining

# HQP



Improved centripetal force with special two-step bottom and double margin  
Excellent cylindricity, roundness and surface finish in steel machining

## 1 Improved centripetal forces delivers high-precision machining

Special two-step bottom, large rake angle and double margin design reduce initial shock for higher-precision machining

Cutting force comparison when entering the workpiece (Internal evaluation)

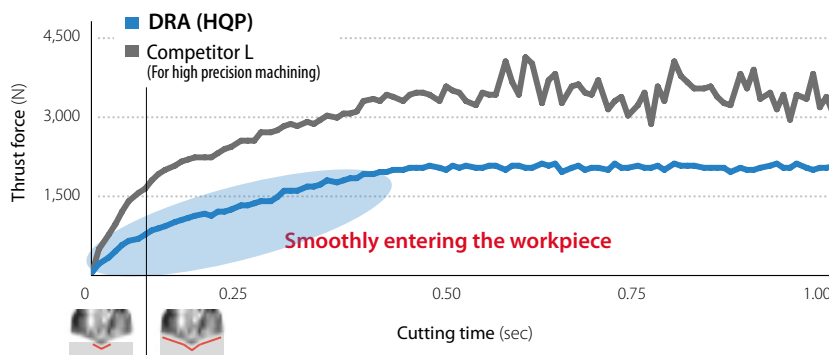

Cutting Conditions: Vc = 100 m/min, f = 0.25 mm/rev, H = 30 mm, Wet Workpiece: S50C ø16 (3D)

Special Two-step bottom



Large rake angle



Double margin

Cylindricity and roundness comparison (Internal evaluation)

Machining center (BT50)

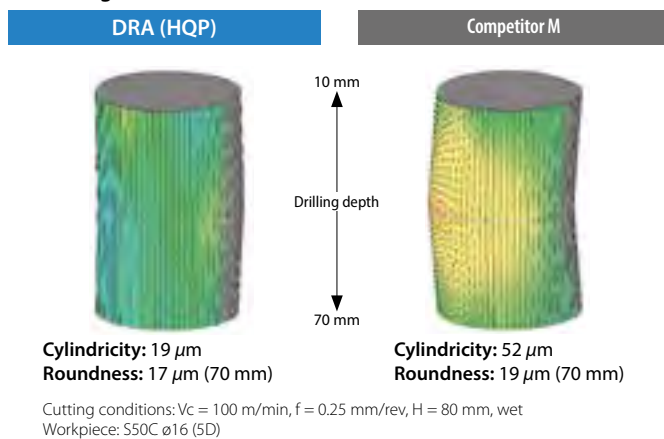

Lathes

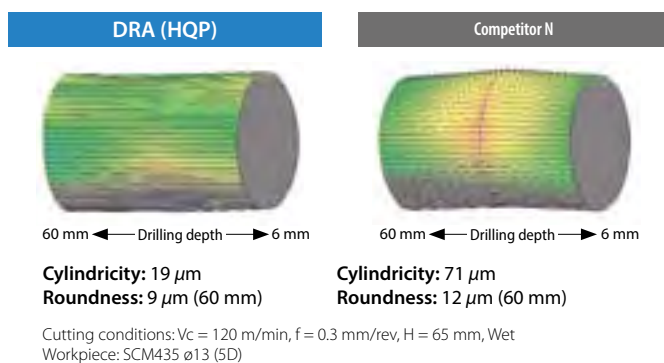

## 2 Excellent surface finish with unique flute shape

Controlled chips reduce scratches on the hole wall

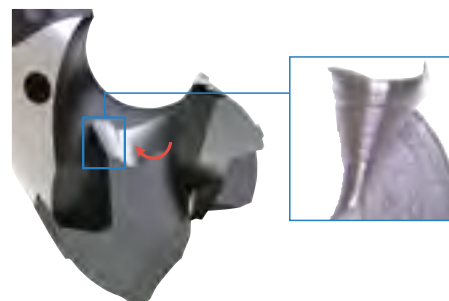

Hole wall surface finish comparison (Internal evaluation)

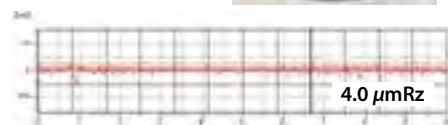

Cutting conditions: Vc = 100 m/min, f = 0.25 mm/rev, H = 80 mm, wet Workpiece: S50C ø16 (5D)

# DRA insert (HQP - High-precision insert for steel) Drilling diameter $\phi 7.94 \sim \phi 19.90$

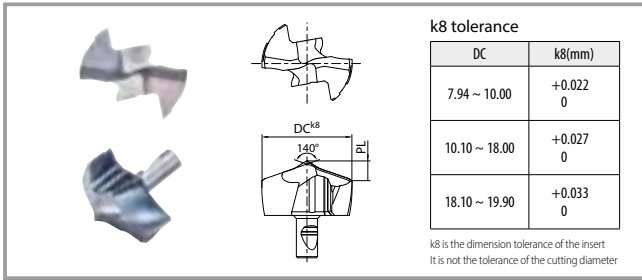

## Insert

Description	Dimensions (mm)		Grade	Applicable toolholder
	DC	PL		
DA 0794M-HQP	7.94	1.90	●	SS10-DRA080M-○ SF12-DRA080M-○
0800M-HQP	8.00	1.91	●	
0810M-HQP	8.10	1.93	●	
0820M-HQP	8.20	1.94	●	
0830M-HQP	8.30	1.96	●	
0840M-HQP	8.40	1.98	●	
DA 0850M-HQP	8.50	1.99	●	SS10-DRA085M-○ SF12-DRA085M-○
0860M-HQP	8.60	2.01	●	
0870M-HQP	8.70	2.03	●	
0880M-HQP	8.80	2.05	●	
0890M-HQP	8.90	2.06	●	
0900M-HQP	9.00	2.19	●	
0910M-HQP	9.10	2.21	●	
0920M-HQP	9.20	2.22	●	
0930M-HQP	9.30	2.24	●	
0940M-HQP	9.40	2.26	●	
0950M-HQP	9.50	2.27	●	SS10-DRA095M-○ SF12-DRA095M-○
0960M-HQP	9.60	2.29	●	
0970M-HQP	9.70	2.31	●	
0980M-HQP	9.80	2.32	●	
0990M-HQP	9.90	2.34	●	
DA 1000M-HQP	10.00	2.35	●	
1010M-HQP	10.10	2.36	●	
1020M-HQP	10.20	2.38	●	
1030M-HQP	10.30	2.40	●	
1040M-HQP	10.40	2.41	●	
1050M-HQP	10.50	2.43	●	SS12-DRA105M-○ SF16-DRA105M-○
1060M-HQP	10.60	2.44	●	
1070M-HQP	10.70	2.46	●	
1080M-HQP	10.80	2.47	●	
1090M-HQP	10.90	2.49	●	
DA 1100M-HQP	11.00	2.65	●	
1110M-HQP	11.10	2.67	●	
1120M-HQP	11.20	2.68	●	
1130M-HQP	11.30	2.70	●	
1140M-HQP	11.40	2.72	●	
DA 1150M-HQP	11.50	2.73	●	SS12-DRA115M-○ SF16-DRA115M-○
1160M-HQP	11.60	2.75	●	
1170M-HQP	11.70	2.76	●	
1180M-HQP	11.80	2.78	●	
1190M-HQP	11.90	2.80	●	
DA 1200M-HQP	12.00	2.79	●	
1210M-HQP	12.10	2.81	●	
1220M-HQP	12.20	2.82	●	
1230M-HQP	12.30	2.84	●	
1240M-HQP	12.40	2.86	●	
DA 1250M-HQP	12.50	2.87	●	SS14-DRA125M-○ SF16-DRA125M-○
1260M-HQP	12.60	2.89	●	
1270M-HQP	12.70	2.91	●	
1280M-HQP	12.80	2.92	●	
1290M-HQP	12.90	2.94	●	
DA 1300M-HQP	13.00	2.98	●	
1310M-HQP	13.10	2.99	●	
1320M-HQP	13.20	3.01	●	
1330M-HQP	13.30	3.02	●	
1340M-HQP	13.40	3.04	●	
DA 1350M-HQP	13.50	3.06	●	SS14-DRA135M-○ SF16-DRA135M-○
1360M-HQP	13.60	3.07	●	
1370M-HQP	13.70	3.09	●	
1380M-HQP	13.80	3.10	●	
1390M-HQP	13.90	3.12	●	

Description	Dimensions (mm)		Grade	Applicable toolholder	
	DC	PL			
DA 1400M-HQP	14.00	3.11	●	SS16-DRA140M-○ SF16-DRA140M-○	
1410M-HQP	14.10	3.12	●		
1420M-HQP	14.20	3.14	●		
1430M-HQP	14.30	3.16	●		
1440M-HQP	14.40	3.17	●		
DA 1450M-HQP	14.50	3.19	●		SS16-DRA145M-○ SF16-DRA145M-○
1460M-HQP	14.60	3.21	●		
1470M-HQP	14.70	3.22	●		
1480M-HQP	14.80	3.24	●		
1490M-HQP	14.90	3.25	●		
DA 1500M-HQP	15.00	3.33	●	SS16-DRA150M-○ SF20-DRA150M-○	
1510M-HQP	15.10	3.35	●		
1520M-HQP	15.20	3.36	●		
1530M-HQP	15.30	3.38	●		
1540M-HQP	15.40	3.39	●		
1550M-HQP	15.50	3.41	●		
1560M-HQP	15.60	3.42	●		
1570M-HQP	15.70	3.44	●		
1580M-HQP	15.80	3.46	●		
1590M-HQP	15.90	3.47	●		
DA 1600M-HQP	16.00	3.55	●		SS18-DRA160M-○ SF20-DRA160M-○
1610M-HQP	16.10	3.57	●		
1620M-HQP	16.20	3.58	●		
1630M-HQP	16.30	3.60	●		
1640M-HQP	16.40	3.62	●		
1650M-HQP	16.50	3.63	●		
1660M-HQP	16.60	3.65	●		
1670M-HQP	16.70	3.66	●		
1680M-HQP	16.80	3.68	●		
1690M-HQP	16.90	3.69	●		
DA 1700M-HQP	17.00	3.73	●	SS18-DRA170M-○ SF20-DRA170M-○	
1710M-HQP	17.10	3.75	●		
1720M-HQP	17.20	3.77	●		
1730M-HQP	17.30	3.78	●		
1740M-HQP	17.40	3.80	●		
1750M-HQP	17.50	3.81	●		
1760M-HQP	17.60	3.83	●		
1770M-HQP	17.70	3.84	●		
1780M-HQP	17.80	3.86	●		
1790M-HQP	17.90	3.88	●		
DA 1800M-HQP	18.00	3.97	●	SS20-DRA180M-○ SF25-DRA180M-○	
1810M-HQP	18.10	3.98	●		
1820M-HQP	18.20	4.00	●		
1830M-HQP	18.30	4.02	●		
1840M-HQP	18.40	4.03	●		
1850M-HQP	18.50	4.05	●		
1860M-HQP	18.60	4.06	●		
1870M-HQP	18.70	4.08	●		
1880M-HQP	18.80	4.09	●		
1890M-HQP	18.90	4.11	●		
DA 1900M-HQP	19.00	4.20	●	SS20-DRA190M-○ SF25-DRA190M-○	
1910M-HQP	19.10	4.22	●		
1920M-HQP	19.20	4.23	●		
1930M-HQP	19.30	4.25	●		
1940M-HQP	19.40	4.26	●		
1950M-HQP	19.50	4.28	●		
1960M-HQP	19.60	4.29	●		
1970M-HQP	19.70	4.31	●		
1980M-HQP	19.80	4.33	●		
1990M-HQP	19.90	4.34	●		

Inserts sold in 1 piece boxes  
● : Available

# HQS NEW



Suitable for machining of difficult-to-cut materials such as Inconel  
High quality and stable machining provide long tool life

## 1 Three features specializing in difficult-to-cut materials machining

### Special two-step bottom



Suppress sudden fracture when entering the workpiece  
Improvement of cutting edge strength

### Double margin



Optimized for difficult-to-cut materials machining  
Improvement of heat resistance

### Unique flute shape



Superior chip control  
Prevents damage to hole walls. Excellent finished surface

## 2 Long tool life and high-quality machining of Inconel and stainless steel

### Inconel

Wear resistance comparison (Internal evaluation)

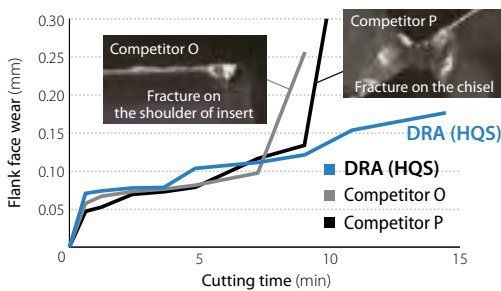

### DRA (HQS)

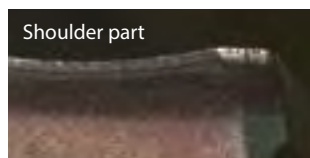

Normal wear condition



Good without fracture

Cutting conditions:  $V_c = 20$  m/min,  $f = 0.15$  mm/rev, Drilling diameter  $\phi 14.5$  (3D)  
Drilling depth 40 mm, wet (internal/external), Workpiece: Inconel 718, BT50 M/C

The shoulder part and chisel part of competitor were fractured and the tool life was shortened.  
HQS maintains long tool life

### Stainless steel

Hole diameter accuracy comparison (Internal evaluation)

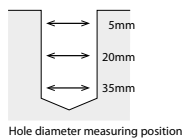
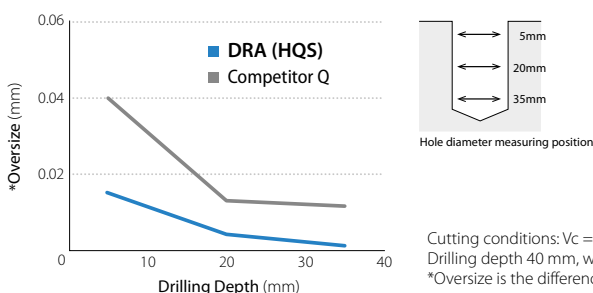

After machining



Good

Rifling occurred

Cutting conditions:  $V_c = 40$  m/min,  $f = 0.10$  mm/rev, Drilling diameter  $\phi 10.8$  (5D)  
Drilling depth 40 mm, wet (internal/external), workpiece: SUS304, BT50 M/C  
\*Oversize is the difference between the actual hole diameter and the drill diameter

HQS has excellent centripetal properties with special two-step bottom and double margin.  
Provides superior hole diameter accuracy



# DRA insert (HQS - difficult-to-cut materials/stainless steel) Drilling diameter ø8.00 to ø19.5

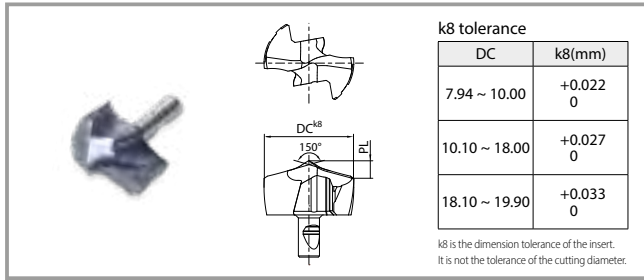

## Insert

Description	Dimensions (mm)		Grade	Applicable toolholder
	DC	PL		
DA 0800M-HQS	8.00	1.76	●	SS10-DRA080M-○ SF12-DRA080M-○
0820M-HQS	8.20	1.78	●	
DA 0850M-HQS	8.50	1.82	●	SS10-DRA085M-○ SF12-DRA085M-○
0870M-HQS	8.70	1.85	●	
0880M-HQS	8.80	1.86	●	
DA 0900M-HQS	9.00	1.97	●	SS10-DRA090M-○ SF12-DRA090M-○
0930M-HQS	9.30	2.01	●	
0940M-HQS	9.40	2.02	●	
DA 0950M-HQS	9.50	2.03	●	SS10-DRA095M-○ SF12-DRA095M-○
0970M-HQS	9.70	2.05	●	
0980M-HQS	9.80	2.06	●	
DA 1000M-HQS	10.00	2.17	●	SS12-DRA100M-○ SF16-DRA100M-○
1030M-HQS	10.30	2.21	●	
1040M-HQS	10.40	2.22	●	
DA 1050M-HQS	10.50	2.23	●	SS12-DRA105M-○ SF16-DRA105M-○
1080M-HQS	10.80	2.27	●	
DA 1100M-HQS	11.00	2.38	●	SS12-DRA110M-○ SF16-DRA110M-○
DA 1150M-HQS	11.50	2.44	●	SS12-DRA115M-○ SF16-DRA115M-○
DA 1200M-HQS	12.00	2.50	●	SS14-DRA120M-○ SF16-DRA120M-○
DA 1250M-HQS	12.50	2.57	●	SS14-DRA125M-○ SF16-DRA125M-○
1260M-HQS	12.60	2.58	●	
DA 1300M-HQS	13.00	2.68	●	SS14-DRA130M-○ SF16-DRA130M-○
DA 1350M-HQS	13.50	2.74	●	SS14-DRA135M-○ SF16-DRA135M-○
1390M-HQS	13.90	2.78	●	

Description	Dimensions (mm)		Grade	Applicable toolholder
	DC	PL		
DA 1400M-HQS	14.00	2.79	●	SS16-DRA140M-○ SF16-DRA140M-○
1420M-HQS	14.20	2.81	●	
DA 1450M-HQS	14.50	2.85	●	SS16-DRA145M-○ SF16-DRA145M-○
DA 1500M-HQS	15.00	2.96	●	SS16-DRA150M-○ SF20-DRA150M-○
1520M-HQS	15.20	2.99	●	
1530M-HQS	15.30	3.00	●	
1550M-HQS	15.50	3.02	●	
1570M-HQS	15.70	3.04	●	
DA 1600M-HQS	16.00	3.18	●	SS18-DRA160M-○ SF20-DRA160M-○
1610M-HQS	16.10	3.20	●	
1620M-HQS	16.20	3.21	●	
1630M-HQS	16.30	3.22	●	
1650M-HQS	16.50	3.25	●	
DA 1700M-HQS	17.00	3.38	●	SS18-DRA170M-○ SF20-DRA170M-○
1750M-HQS	17.50	3.44	●	
1770M-HQS	17.70	3.46	●	
DA 1800M-HQS	18.00	3.59	●	SS20-DRA180M-○ SF25-DRA180M-○
1810M-HQS	18.10	3.60	●	
1850M-HQS	18.50	3.65	●	
DA 1900M-HQS	19.00	3.79	●	SS20-DRA190M-○ SF25-DRA190M-○
1930M-HQS	19.30	3.82	●	
1950M-HQS	19.50	3.84	●	

Inserts sold in 1 piece boxes  
● : Available

**HQS can be customized within the range of ø 7.94 to ø 19.90 in drilling diameter**  
**For more information, please contact a Kyocera sales representative.**

# DRA insert (GM - General purpose) Drilling diameter $\phi 7.94 \sim \phi 33.00$



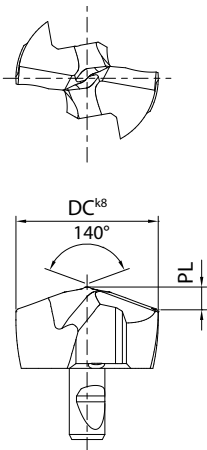

**k8 tolerance**

DC	k8(mm)
7.94 ~ 10.00	+0.022 0
10.10 ~ 18.00	+0.027 0
18.10 ~ 30.00	+0.033 0
30.10 ~ 33.00	+0.039 0

k8 is the dimension tolerance of the insert  
It is not the tolerance of the cutting diameter

## Insert

1st recommendation

Steel / Stainless steel PR1535	Cast iron PR1525
-----------------------------------	---------------------

Description	Dimensions (mm)		Grade		Applicable toolholder
	DC	PL	PR1535	PR1525	
DA 0794M-GM	7.94	1.34	●	●	SS10-DRA080M-○ SF12-DRA080M-○
0800M-GM	8.00	1.35	●	●	
0810M-GM	8.10	1.37	●	●	
0820M-GM	8.20	1.38	●	●	
0830M-GM	8.30	1.40	●	●	
0840M-GM	8.40	1.42	●	●	
DA 0850M-GM	8.50	1.44	●	●	SS10-DRA085M-○ SF12-DRA085M-○
0860M-GM	8.60	1.46	●	●	
0870M-GM	8.70	1.48	●	●	
0880M-GM	8.80	1.49	●	●	
0890M-GM	8.90	1.51	●	●	
DA 0900M-GM	9.00	1.52	●	●	SS10-DRA090M-○ SF12-DRA090M-○
0910M-GM	9.10	1.54	●	●	
0920M-GM	9.20	1.56	●	●	
0930M-GM	9.30	1.58	●	●	
0940M-GM	9.40	1.59	●	●	
DA 0950M-GM	9.50	1.61	●	●	SS10-DRA095M-○ SF12-DRA095M-○
0960M-GM	9.60	1.63	●	●	
0970M-GM	9.70	1.65	●	●	
0980M-GM	9.80	1.67	●	●	
0990M-GM	9.90	1.68	●	●	
DA 1000M-GM	10.00	1.70	●	●	SS12-DRA100M-○ SF16-DRA100M-○
1010M-GM	10.10	1.72	●	●	
1020M-GM	10.20	1.74	●	●	
1030M-GM	10.30	1.75	●	●	
1040M-GM	10.40	1.77	●	●	
DA 1050M-GM	10.50	1.79	●	●	SS12-DRA105M-○ SF16-DRA105M-○
1060M-GM	10.60	1.81	●	●	
1070M-GM	10.70	1.83	●	●	
1080M-GM	10.80	1.85	●	●	
1090M-GM	10.90	1.86	●	●	
DA 1100M-GM	11.00	1.87	●	●	SS12-DRA110M-○ SF16-DRA110M-○
1110M-GM	11.10	1.89	●	●	
1120M-GM	11.20	1.91	●	●	
1130M-GM	11.30	1.92	●	●	
1140M-GM	11.40	1.94	●	●	
DA 1150M-GM	11.50	1.96	●	●	SS12-DRA115M-○ SF16-DRA115M-○
1160M-GM	11.60	1.98	●	●	
1170M-GM	11.70	2.00	●	●	
1180M-GM	11.80	2.01	●	●	
1190M-GM	11.90	2.03	●	●	
DA 1200M-GM	12.00	2.03	●	●	SS14-DRA120M-○ SF16-DRA120M-○
1210M-GM	12.10	2.05	●	●	
1220M-GM	12.20	2.07	●	●	
1230M-GM	12.30	2.08	●	●	
1240M-GM	12.40	2.10	●	●	
DA 1250M-GM	12.50	2.12	●	●	SS14-DRA125M-○ SF16-DRA125M-○
1260M-GM	12.60	2.14	●	●	
1270M-GM	12.70	2.16	●	●	
1280M-GM	12.80	2.17	●	●	
1290M-GM	12.90	2.19	●	●	

Description	Dimensions (mm)		Grade		Applicable toolholder
	DC	PL	PR1535	PR1525	
DA 1300M-GM	13.00	2.20	●	●	SS14-DRA130M-○ SF16-DRA130M-○
1310M-GM	13.10	2.22	●	●	
1320M-GM	13.20	2.24	●	●	
1330M-GM	13.30	2.25	●	●	
1340M-GM	13.40	2.27	●	●	
DA 1350M-GM	13.50	2.29	●	●	SS14-DRA135M-○ SF16-DRA135M-○
1360M-GM	13.60	2.31	●	●	
1370M-GM	13.70	2.33	●	●	
1380M-GM	13.80	2.35	●	●	
1390M-GM	13.90	2.36	●	●	
DA 1400M-GM	14.00	2.33	●	●	SS16-DRA140M-○ SF16-DRA140M-○
1410M-GM	14.10	2.34	●	●	
1420M-GM	14.20	2.36	●	●	
1430M-GM	14.30	2.38	●	●	
1440M-GM	14.40	2.40	●	●	
DA 1450M-GM	14.50	2.42	●	●	SS16-DRA145M-○ SF16-DRA145M-○
1460M-GM	14.60	2.43	●	●	
1470M-GM	14.70	2.45	●	●	
1480M-GM	14.80	2.47	●	●	
1490M-GM	14.90	2.49	●	●	
DA 1500M-GM	15.00	2.52	●	●	SS16-DRA150M-○ SF20-DRA150M-○
1510M-GM	15.10	2.54	●	●	
1520M-GM	15.20	2.55	●	●	
1530M-GM	15.30	2.57	●	●	
1540M-GM	15.40	2.59	●	●	
1550M-GM	15.50	2.61	●	●	
1560M-GM	15.60	2.63	●	●	
1570M-GM	15.70	2.65	●	●	
1580M-GM	15.80	2.66	●	●	
1590M-GM	15.90	2.68	●	●	
DA 1600M-GM	16.00	2.69	●	●	SS18-DRA160M-○ SF20-DRA160M-○
1610M-GM	16.10	2.71	●	●	
1620M-GM	16.20	2.73	●	●	
1630M-GM	16.30	2.75	●	●	
1640M-GM	16.40	2.76	●	●	
1650M-GM	16.50	2.78	●	●	
1660M-GM	16.60	2.80	●	●	
1670M-GM	16.70	2.82	●	●	
1680M-GM	16.80	2.84	●	●	
1690M-GM	16.90	2.86	●	●	
DA 1700M-GM	17.00	2.86	●	●	SS18-DRA170M-○ SF20-DRA170M-○
1710M-GM	17.10	2.88	●	●	
1720M-GM	17.20	2.90	●	●	
1730M-GM	17.30	2.92	●	●	
1740M-GM	17.40	2.93	●	●	
1750M-GM	17.50	2.95	●	●	
1760M-GM	17.60	2.97	●	●	
1770M-GM	17.70	2.99	●	●	
1780M-GM	17.80	3.01	●	●	
1790M-GM	17.90	3.03	●	●	

Inserts sold in 1 piece boxes  
●: Available

# DRA insert (GM - General purpose) Drilling diameter $\phi 7.94 \sim \phi 33.00$

**k8 tolerance**

DC	k8(mm)
7.94 ~ 10.00	+0.022 0
10.10 ~ 18.00	+0.027 0
18.10 ~ 30.00	+0.033 0
30.10 ~ 33.00	+0.039 0

k8 is the dimension tolerance of the insert  
It is not the tolerance of the cutting diameter

## Insert

1st recommendation  
Steel / Stainless steel PR1535 Cast iron PR1525

Description	Dimensions (mm)		Grade		Applicable toolholder
	DC	PL	PR1535	PR1525	
DA 1800M-GM	18.00	3.04	●	●	SS20-DRA180M-○ SF25-DRA180M-○
1810M-GM	18.10	3.06	●	●	
1820M-GM	18.20	3.07	●	●	
1830M-GM	18.30	3.09	●	●	
1840M-GM	18.40	3.11	●	●	
1850M-GM	18.50	3.13	●	●	
1860M-GM	18.60	3.15	●	●	
1870M-GM	18.70	3.17	●	●	
1880M-GM	18.80	3.18	●	●	
1890M-GM	18.90	3.20	●	●	
DA 1900M-GM	19.00	3.21	●	●	SS20-DRA190M-○ SF25-DRA190M-○
1910M-GM	19.10	3.23	●	●	
1920M-GM	19.20	3.25	●	●	
1930M-GM	19.30	3.27	●	●	
1940M-GM	19.40	3.29	●	●	
1950M-GM	19.50	3.30	●	●	
1960M-GM	19.60	3.32	●	●	
1970M-GM	19.70	3.34	●	●	
1980M-GM	19.80	3.36	●	●	
1990M-GM	19.90	3.38	●	●	
DA 2000M-GM	20.00	3.37	●	●	SS25-DRA200M-○ SF25-DRA200M-○
2010M-GM	20.10	3.39	●	●	
2020M-GM	20.20	3.41	●	●	
2030M-GM	20.30	3.43	●	●	
2040M-GM	20.40	3.45	●	●	
2050M-GM	20.50	3.46	●	●	
2060M-GM	20.60	3.48	●	●	
2070M-GM	20.70	3.50	●	●	
2080M-GM	20.80	3.52	●	●	
2090M-GM	20.90	3.54	●	●	

Description	Dimensions (mm)		Grade		Applicable toolholder
	DC	PL	PR1535	PR1525	
DA 2100M-GM	21.00	3.54	●	●	SS25-DRA210M-○
2150M-GM	21.50	3.63	●	●	SF25-DRA210M-○
DA 2200M-GM	22.00	3.71	●	●	SS25-DRA220M-○
2250M-GM	22.50	3.80	●	●	SF25-DRA220M-○
DA 2300M-GM	23.00	3.87	●	●	SS25-DRA230M-○
2350M-GM	23.50	3.96	●	●	SF25-DRA230M-○
DA 2400M-GM	24.00	4.04	●	●	SS25-DRA240M-○
2450M-GM	24.50	4.13	●	●	SF25-DRA240M-○
DA 2500M-GM	25.00	4.20	●	●	SS32-DRA250M-○
2550M-GM	25.50	4.29	●	●	SF25-DRA250M-○
DA 2600M-GM	26.00	4.80	●	●	SF32-DRA260M-○
2650M-GM	26.50	4.90	●	●	
DA 2700M-GM	27.00	4.99	●	●	SF32-DRA270M-○
2750M-GM	27.50	5.09	●	●	
DA 2800M-GM	28.00	4.73	●	●	SF32-DRA280M-○
2850M-GM	28.50	4.83	●	●	
DA 2900M-GM	29.00	4.90	●	●	SF32-DRA290M-○
2950M-GM	29.50	5.01	●	●	
DA 3000M-GM	30.00	5.07	●	●	SF32-DRA300M-○
3050M-GM	30.50	5.17	●	●	
DA 3100M-GM	31.00	5.26	●	●	SF32-DRA310M-○
3150M-GM	31.50	5.37	●	●	
DA 3200M-GM	32.00	5.41	●	●	SF32-DRA320M-○
3250M-GM	32.50	5.51	●	●	
3300M-GM	33.00	5.62	●	●	

Inserts sold in 1 piece boxes  
● : Available

## Description identification system (Insert)

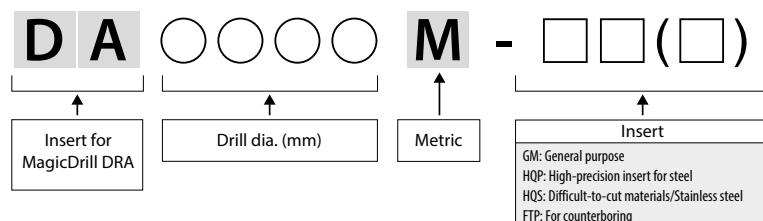

# DRA insert (FTP - Counterboring) Drilling diameter $\varnothing 8.00 \sim \varnothing 25.40$



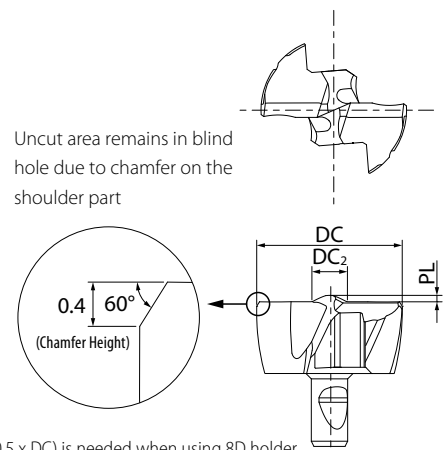

Uncut area remains in blind hole due to chamfer on the shoulder part

**k8 tolerance**

DC	k8(mm)
8.00 ~ 10.00	+0.022 0
10.10 ~ 18.00	+0.027 0
18.10 ~ 25.40	+0.033 0

k8 is the dimension tolerance of the insert  
It is not the tolerance of the cutting diameter

**Note**  
Applicable to 1.5D, 3D, 5D and 8D holders, Prepared hole (0.5 x DC) is needed when using 8D holder

## Insert

1st recommendation

Steel / Stainless steel PR1535	Cast Iron PR1525
-----------------------------------	---------------------

Description	Dimensions (mm)			Grade		Applicable toolholder
	DC	DC <sub>2</sub>	PL	PR1535	PR1525	
DA0800M-FTP	8.00	2.90	0.40	●	●	SS10-DRA080M-○ SF12-DRA080M-○
DA0830M-FTP	8.30			●	●	
DA0850M-FTP	8.50			●	●	SS10-DRA085M-○ SF12-DRA085M-○
DA0880M-FTP	8.80			●	●	
DA0900M-FTP	9.00	3.00	0.43	●	●	SS10-DRA090M-○ SF12-DRA090M-○
DA0930M-FTP	9.30			●	●	
DA0950M-FTP	9.50			●	●	SS10-DRA095M-○ SF12-DRA095M-○
DA1000M-FTP	10.00	3.30	0.46	●	●	SS12-DRA100M-○ SF16-DRA100M-○
DA1030M-FTP	10.30			●	●	
DA1050M-FTP	10.50			●	●	SS12-DRA105M-○ SF16-DRA105M-○
DA1080M-FTP	10.80			●	●	
DA1100M-FTP	11.00	3.40	0.50	●	●	SS12-DRA110M-○ SF16-DRA110M-○
DA1150M-FTP	11.50			●	●	SS12-DRA115M-○ SF16-DRA115M-○
DA1200M-FTP	12.00	3.70	0.53	●	●	SS14-DRA120M-○ SF16-DRA120M-○
DA1250M-FTP	12.50			●	●	SS14-DRA125M-○ SF16-DRA125M-○
DA1270M-FTP	12.70			●	●	
DA1300M-FTP	13.00	3.90	0.56	●	●	SS14-DRA130M-○ SF16-DRA130M-○
DA1350M-FTP	13.50			●	●	SS14-DRA135M-○ SF16-DRA135M-○
DA1400M-FTP	14.00	4.20	0.60	●	●	SS16-DRA140M-○ SF16-DRA140M-○
DA1450M-FTP	14.50			●	●	SS16-DRA145M-○ SF16-DRA145M-○
DA1500M-FTP	15.00			●	●	SS16-DRA150M-○ SF20-DRA150M-○

Description	Dimensions (mm)			Grade		Applicable toolholder
	DC	DC <sub>2</sub>	PL	PR1535	PR1525	
DA1550M-FTP	15.50	4.40	0.65	●	●	SS16-DRA150M-○ SF20-DRA150M-○
DA1600M-FTP	16.00	4.60	0.70	●	●	SS18-DRA160M-○ SF20-DRA160M-○
DA1650M-FTP	16.50			●	●	
DA1700M-FTP	17.00	5.00	0.75	●	●	SS18-DRA170M-○ SF20-DRA170M-○
DA1750M-FTP	17.50			●	●	
DA1800M-FTP	18.00	5.00	0.80	●	●	SS20-DRA180M-○ SF25-DRA180M-○
DA1850M-FTP	18.50			●	●	
DA1900M-FTP	19.00	5.30	0.85	●	●	SS20-DRA190M-○ SF25-DRA190M-○
DA1950M-FTP	19.50			●	●	
DA2000M-FTP	20.00	5.70	0.90	●	●	SS25-DRA200M-○ SF25-DRA200M-○
DA2050M-FTP	20.50			●	●	
DA2100M-FTP	21.00	6.00	0.95	●	●	SS25-DRA210M-○ SF25-DRA210M-○
DA2150M-FTP	21.50			●	●	
DA2200M-FTP	22.00	6.40	1.00	●	●	SS25-DRA220M-○ SF25-DRA220M-○
DA2250M-FTP	22.50			●	●	
DA2300M-FTP	23.00	6.60	1.05	●	●	SS25-DRA230M-○ SF25-DRA230M-○
DA2350M-FTP	23.50			●	●	
DA2400M-FTP	24.00	6.80	1.10	●	●	SS25-DRA240M-○ SF25-DRA240M-○
DA2450M-FTP	24.50			●	●	
DA2500M-FTP	25.00	7.00	1.20	●	●	SS32-DRA250M-○ SF25-DRA250M-○
DA2540M-FTP	25.40			●	●	

Inserts sold in 1 piece boxes  
●: Available

## Applicable workpiece and Not recommended workpiece

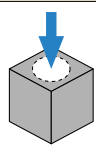
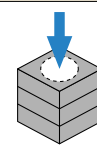
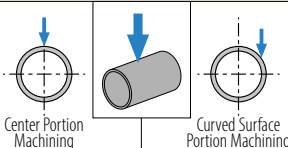
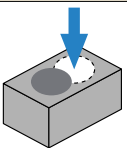
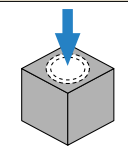
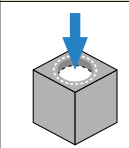
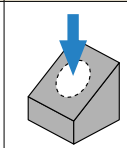
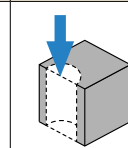
Plain Surface	Stacked plates	Pipe material	*Hole expansion	Cored hole	Concave surface	Slant surface	Half cylindrical
							
← 1.5D holder recommended →							Non-recommended
← Over 3D holder recommended →			Over 3D holder not recommended shape				

\*Overlap should be under 1/3 x DC in hole expansion with 1.5D holder

## DRA toolholder (Straight shank)

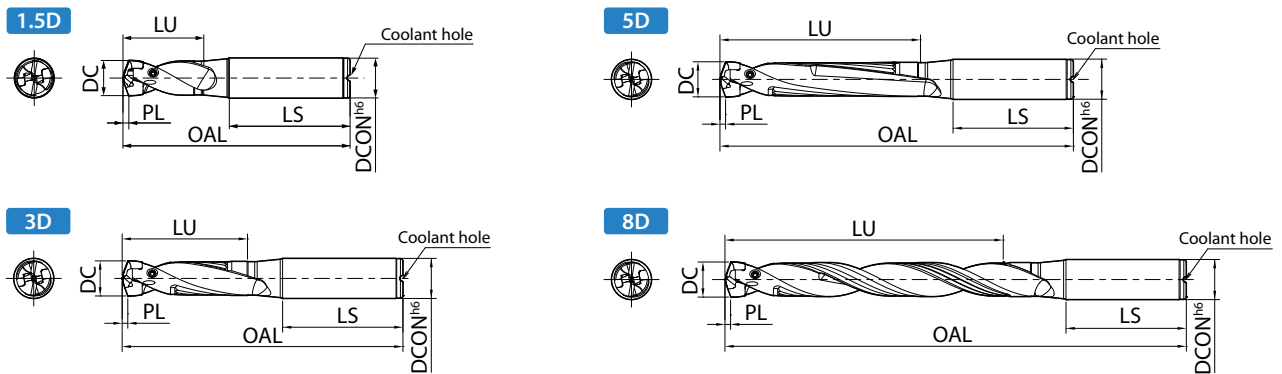

### Toolholder dimensions **1.5D**

Description	Availability	Dimensions (mm)					Applicable insert	Spare parts		
		DC		DCON (h6)	OAL	LU		LS	Clamp screw	Wrench
		min.	max.							
SS10-DRA080M-1.5	●	7.94	8.49	10	66.2	12.8	40	DA0794M-... ~ DA0840M-... DA0850M-... ~ DA0890M-... DA0900M-... ~ DA0940M-... DA0950M-... ~ DA0990M-...	HS-2524TRP	FTP-5
SS10-DRA085M-1.5	●	8.50	8.99		67.5	13.5				
SS10-DRA090M-1.5	●	9.00	9.49		68.7	14.3				
SS10-DRA095M-1.5	●	9.50	9.99		70.0	15.0				
SS12-DRA100M-1.5	●	10.00	10.49	12	76.2	15.8	45	DA1000M-... ~ DA1040M-... DA1050M-... ~ DA1090M-... DA1100M-... ~ DA1140M-... DA1150M-... ~ DA1190M-...	HS-2534TRP	
SS12-DRA105M-1.5	●	10.50	10.99		77.5	16.5				
SS12-DRA110M-1.5	●	11.00	11.49		79.7	17.3				
SS12-DRA115M-1.5	●	11.50	11.99		81.0	18.0				
SS14-DRA120M-1.5	●	12.00	12.49	14	82.2	18.8	48	DA1200M-... ~ DA1240M-... DA1250M-... ~ DA1290M-... DA1300M-... ~ DA1340M-... DA1350M-... ~ DA1390M-...	HS-3048TRP	
SS14-DRA125M-1.5	●	12.50	12.99		83.5	19.5				
SS14-DRA130M-1.5	●	13.00	13.49		84.7	20.3				
SS14-DRA135M-1.5	●	13.50	13.99		86.0	21.0				
SS16-DRA140M-1.5	●	14.00	14.49	16	90.2	21.8	50	DA1400M-... ~ DA1440M-... DA1450M-... ~ DA1490M-... DA1500M-... ~ DA1590M-... DA1600M-... ~ DA1690M-...	HS-3048TRP	
SS16-DRA145M-1.5	●	14.50	14.99		91.5	22.5				
SS16-DRA150M-1.5	●	15.00	15.99		95.0	24.0				
SS18-DRA160M-1.5	●	16.00	16.99		18	98.5				25.5
SS18-DRA170M-1.5	●	17.00	17.99	101.0		27.0				
SS20-DRA180M-1.5	●	18.00	18.99	20	106.5	28.5	56	DA1800M-... ~ DA1890M-... DA1900M-... ~ DA1990M-...	HS-4067TRP	
SS20-DRA190M-1.5	●	19.00	19.99		109.0	30.0				
SS25-DRA200M-1.5	●	20.00	20.99	25	117.5	31.5	60	DA2000M-... ~ DA2090M-... DA2100M-... ~ DA2150M-... DA2200M-... ~ DA2250M-... DA2300M-... ~ DA2350M-... DA2400M-... ~ DA2450M-... DA2500M-... ~ DA2550M-...	DTP-7	
SS25-DRA210M-1.5	●	21.00	21.99		120.0	33.0				
SS25-DRA220M-1.5	●	22.00	22.99		123.5	34.5				
SS25-DRA230M-1.5	●	23.00	23.99		126.0	36.0				
SS25-DRA240M-1.5	●	24.00	24.99		128.5	37.5				
SS32-DRA250M-1.5	●	25.00	25.50		135.0	39.0				

● : Available

**Toolholder dimensions 3D**

Description	Availability	Dimensions (mm)					Applicable insert	Spare parts				
		DC		DCON (h6)	OAL	LU		LS	Clamp screw	Wrench		
		min.	max.									
SS10-DRA080M-3	●	7.94	8.49	10	79	25.5	40	DA0794M-... ~ DA0840M-...	HS-2524TRP	FTP-5		
SS10-DRA085M-3	●	8.50	8.99		81	27.0		DA0850M-... ~ DA0890M-...				
SS10-DRA090M-3	●	9.00	9.49		83	28.5		DA0900M-... ~ DA0940M-...				
SS10-DRA095M-3	●	9.50	9.99		85	30.0		DA0950M-... ~ DA0990M-...				
SS12-DRA100M-3	●	10.00	10.49	12	92	31.5	45	DA1000M-... ~ DA1040M-...	HS-2534TRP		FTP-5	
SS12-DRA105M-3	●	10.50	10.99		94	33.0		DA1050M-... ~ DA1090M-...				
SS12-DRA110M-3	●	11.00	11.49		97	34.5		DA1100M-... ~ DA1140M-...				
SS12-DRA115M-3	●	11.50	11.99		99	36.0		DA1150M-... ~ DA1190M-...				
SS14-DRA120M-3	●	12.00	12.49	14	101	37.5	48	DA1200M-... ~ DA1240M-...	HS-3048TRP			DTP-6
SS14-DRA125M-3	●	12.50	12.99		103	39.0		DA1250M-... ~ DA1290M-...				
SS14-DRA130M-3	●	13.00	13.49		105	40.5		DA1300M-... ~ DA1340M-...				
SS14-DRA135M-3	●	13.50	13.99		107	42.0		DA1350M-... ~ DA1390M-...				
SS16-DRA140M-3	●	14.00	14.49	16	112	43.5	50	DA1400M-... ~ DA1440M-...	HS-4067TRP	DTP-7		
SS16-DRA145M-3	●	14.50	14.99		114	45.0		DA1450M-... ~ DA1490M-...				
SS16-DRA150M-3	●	15.00	15.99		119	48.0		DA1500M-... ~ DA1590M-...				
SS18-DRA160M-3	●	16.00	16.99		124	51.0		DA1600M-... ~ DA1690M-...				
SS18-DRA170M-3	●	17.00	17.99	18	128	54.0	DA1700M-... ~ DA1790M-...	HS-3048TRP	DTP-6			
SS20-DRA180M-3	●	18.00	18.99	20	135	57.0	DA1800M-... ~ DA1890M-...					
SS20-DRA190M-3	●	19.00	19.99		139	60.0	DA1900M-... ~ DA1990M-...					
SS25-DRA200M-3	●	20.00	20.99	25	149	63.0	DA2000M-... ~ DA2090M-...				HS-4067TRP	
SS25-DRA210M-3	●	21.00	21.99		153	66.0	DA2100M-... ~ DA2150M-...					
SS25-DRA220M-3	●	22.00	22.99		158	69.0	DA2200M-... ~ DA2250M-...					
SS25-DRA230M-3	●	23.00	23.99		162	72.0	DA2300M-... ~ DA2350M-...					
SS25-DRA240M-3	●	24.00	24.99		166	75.0	DA2400M-... ~ DA2450M-...					
SS32-DRA250M-3	●	25.00	25.50		32	174	78.0	DA2500M-... ~ DA2550M-...				

● : Available

**Toolholder dimensions 5D**

Description	Availability	Dimensions (mm)					Applicable insert	Spare parts				
		DC		DCON (h6)	OAL	LU		LS	Clamp screw	Wrench		
		min.	max.									
SS10-DRA080M-5	●	7.94	8.49	10	96	42.5	40	DA0794M-... ~ DA0840M-...	HS-2524TRP	FTP-5		
SS10-DRA085M-5	●	8.50	8.99		99	45.0		DA0850M-... ~ DA0890M-...				
SS10-DRA090M-5	●	9.00	9.49		102	47.5		DA0900M-... ~ DA0940M-...				
SS10-DRA095M-5	●	9.50	9.99		105	50.0		DA0950M-... ~ DA0990M-...				
SS12-DRA100M-5	●	10.00	10.49	12	113	52.5	45	DA1000M-... ~ DA1040M-...	HS-2534TRP		FTP-5	
SS12-DRA105M-5	●	10.50	10.99		116	55.0		DA1050M-... ~ DA1090M-...				
SS12-DRA110M-5	●	11.00	11.49		120	57.5		DA1100M-... ~ DA1140M-...				
SS12-DRA115M-5	●	11.50	11.99		123	60.0		DA1150M-... ~ DA1190M-...				
SS14-DRA120M-5	●	12.00	12.49	14	126	62.5	48	DA1200M-... ~ DA1240M-...	HS-3048TRP			DTP-6
SS14-DRA125M-5	●	12.50	12.99		129	65.0		DA1250M-... ~ DA1290M-...				
SS14-DRA130M-5	●	13.00	13.49		132	67.5		DA1300M-... ~ DA1340M-...				
SS14-DRA135M-5	●	13.50	13.99		135	70.0		DA1350M-... ~ DA1390M-...				
SS16-DRA140M-5	●	14.00	14.49	16	141	72.5	50	DA1400M-... ~ DA1440M-...	HS-4067TRP	DTP-7		
SS16-DRA145M-5	●	14.50	14.99		144	75.0		DA1450M-... ~ DA1490M-...				
SS16-DRA150M-5	●	15.00	15.99		151	80.0		DA1500M-... ~ DA1590M-...				
SS18-DRA160M-5	●	16.00	16.99		158	85.0		DA1600M-... ~ DA1690M-...				
SS18-DRA170M-5	●	17.00	17.99	18	164	90.0	DA1700M-... ~ DA1790M-...	HS-3048TRP	DTP-6			
SS20-DRA180M-5	●	18.00	18.99	20	173	95.0	DA1800M-... ~ DA1890M-...					
SS20-DRA190M-5	●	19.00	19.99		179	100.0	DA1900M-... ~ DA1990M-...					
SS25-DRA200M-5	●	20.00	20.99	25	191	105.0	DA2000M-... ~ DA2090M-...				HS-4067TRP	
SS25-DRA210M-5	●	21.00	21.99		197	110.0	DA2100M-... ~ DA2150M-...					
SS25-DRA220M-5	●	22.00	22.99		204	115.0	DA2200M-... ~ DA2250M-...					
SS25-DRA230M-5	●	23.00	23.99		210	120.0	DA2300M-... ~ DA2350M-...					
SS25-DRA240M-5	●	24.00	24.99		216	125.0	DA2400M-... ~ DA2450M-...					
SS32-DRA250M-5	●	25.00	25.50		32	226	130.0	DA2500M-... ~ DA2550M-...				

● : Available

Toolholder dimensions **8D**

Description	Availability	Dimensions (mm)					Applicable insert	Spare parts		
		DC		DCON (h6)	OAL	LU		LS	Clamp screw	Wrench
		min.	max.							
SS10-DRA080M-8	●	7.94	8.49	10	121	68.0	40	DA0794M-... ~ DA0840M-...	HS-2524TRP	FTP-5
SS10-DRA085M-8	●	8.50	8.99		126	72.0		DA0850M-... ~ DA0890M-...		
SS10-DRA090M-8	●	9.00	9.49		130	76.0		DA0900M-... ~ DA0940M-...		
SS10-DRA095M-8	●	9.50	9.99		135	80.0		DA0950M-... ~ DA0990M-...		
SS12-DRA100M-8	●	10.00	10.49	12	144	84.0	45	DA1000M-... ~ DA1040M-...	HS-2534TRP	
SS12-DRA105M-8	●	10.50	10.99		149	88.0		DA1050M-... ~ DA1090M-...		
SS12-DRA110M-8	●	11.00	11.49		154	92.0		DA1100M-... ~ DA1140M-...		
SS12-DRA115M-8	●	11.50	11.99		159	96.0		DA1150M-... ~ DA1190M-...		
SS14-DRA120M-8	●	12.00	12.49	14	163	100.0	48	DA1200M-... ~ DA1240M-...	HS-3048TRP	
SS14-DRA125M-8	●	12.50	12.99		168	104.0		DA1250M-... ~ DA1290M-...		
SS14-DRA130M-8	●	13.00	13.49		172	108.0		DA1300M-... ~ DA1340M-...		
SS14-DRA135M-8	●	13.50	13.99		177	112.0		DA1350M-... ~ DA1390M-...		
SS16-DRA140M-8	●	14.00	14.49	16	184	116.0	50	DA1400M-... ~ DA1440M-...	HS-4067TRP	
SS16-DRA145M-8	●	14.50	14.99		189	120.0		DA1450M-... ~ DA1490M-...		
SS16-DRA150M-8	●	15.00	15.99		199	128.0		DA1500M-... ~ DA1590M-...		
SS18-DRA160M-8	●	16.00	16.99		209	136.0		DA1600M-... ~ DA1690M-...		
SS18-DRA170M-8	●	17.00	17.99	18	218	144.0	56	DA1700M-... ~ DA1790M-...	DTP-6	
SS20-DRA180M-8	●	18.00	18.99	20	230	152.0	56	DA1800M-... ~ DA1890M-...		
SS20-DRA190M-8	●	19.00	19.99		239	160.0		DA1900M-... ~ DA1990M-...		
SS25-DRA200M-8	●	20.00	20.99	25	254	168.0	60	DA2000M-... ~ DA2090M-...		
SS25-DRA210M-8	●	21.00	21.99		263	176.0		DA2100M-... ~ DA2150M-...		
SS25-DRA220M-8	●	22.00	22.99		273	184.0		DA2200M-... ~ DA2250M-...		
SS25-DRA230M-8	●	23.00	23.99		282	192.0		DA2300M-... ~ DA2350M-...		
SS25-DRA240M-8	●	24.00	24.99		291	200.0		DA2400M-... ~ DA2450M-...		
SS32-DRA250M-8	●	25.00	25.50		32	304		208.0	60	DA2500M-... ~ DA2550M-...

● : Available

Spare parts

Clamp screw	Description
	HS-2524TRP
	HS-2534TRP
	HS-3048TRP
	HS-4067TRP

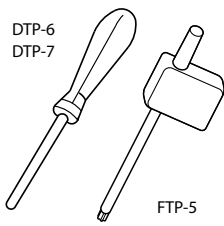
Wrench	Description	Torque (N · m)
	FTP-5	0.5
	DTP-6	0.8
	DTP-7	1.2

Description identification system (Toolholder)



# Chamfering Attachment

Applicable to straight shank DRA type

Excellent chip control in a wide range of drilling depths

## 1 Excellent stability and chip evacuation

Easy-to-adjust chamfering insert slides in radial direction with a clamp structure that provides good chip evacuation

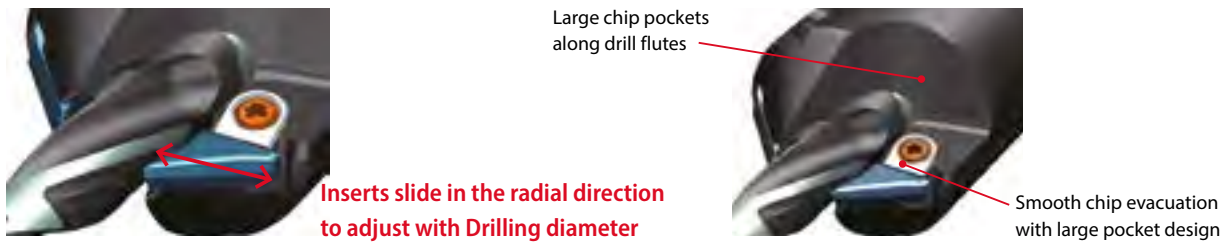

## 2 Fully adjustable for a wide range of drilling depths

Range of adjustable depths for a  $\phi 14$  mm drilling diameter

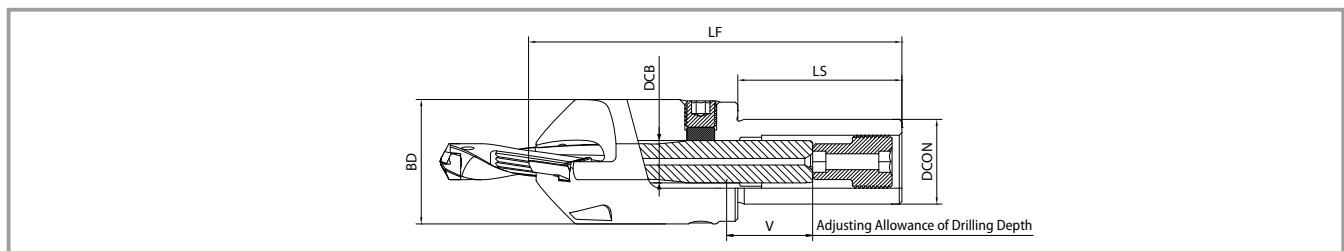

### Toolholder

Description	Availability	Applicable drill shank dia. DCB	Dimensions (mm)					Applicable insert
			DCON	BD	LF	LS	V (Max)	
S20-CH10-DRA	●	10	20	39	110	52	18	CT12T3-45DA
S32-CH12-DRA	●	12	32	43	130	62	24	
S32-CH14-DRA	●	14	32	45	130	62	24	
S32-CH16-DRA	●	16	32	47	141	62	24	
S32-CH18-DRA	●	18	32	49	145	62	24	
S32-CH20-DRA	●	20	32	53	150	62	24.5	







● : Available

### Applicable insert

Shape	Description	MEGACOAT NANO		Dimensions (mm)	
		PR1535		W1	S
	CT12T3-45DA	●		13.54	3.97

● : Available

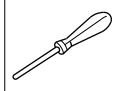

Chamfering attachment	Adjusting screw		For fixing drills				For mounting inserts			
			Clamp	Clamp screw		Plug screw	Clamp	Clamp screw	Wrench	
Description		Width across flat (mm)			Width across flat (mm)	Torque [N·m]				
S20-CH10-DRA	AJ-12X22	6	CP-CH10	HS8X8	4	12	BNP6	C09N	W6X18N	DTM-15
S32-CH12-DRA	AJ-16X30		CP-CH12			15				
S32-CH14-DRA	AJ-20X30	8	CP-CH14	HS10X10	5	20				
S32-CH16-DRA			CP-CH16	HS12X10	6	30				
S32-CH18-DRA	AJ-22x35	10	CP-CH18			30				
S32-CH20-DRA			CP-CH20	HS16X10	8	45				

### Drilling and chamfering depths

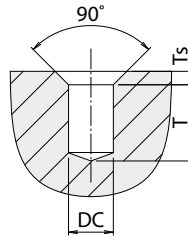

Cutting dia. (mm) DC		Drilling depth (mm)						Chamfering dimension (mm)		Applicable toolholder
		T (3XD)		T (5XD)		T (8XD)		Ts	Tsmax.	
min.	max.	min.	max.	min.	max.	min.	max.			
7.94	8.49	12.5	20	18	36	43	60	2.5	8	S20-CH10-DRA
8.50	8.99	12.5	21.5	21.5	38.5	48	64			
9.00	9.49	12.5	23	24	41	52	68			
9.50	9.99	12.5	24.5	27.5	43.5	57.5	72.5	4	8	S32-CH12-DRA
10.00	10.49	15.5	26	22	46	52	76			
10.50	10.99	16	27.5	24.5	48.5	56	80			
11.00	11.49	16.5	29	27	51	60	84			
11.50	11.99	17.5	30.5	29.5	53.5	64	88	4	8	S32-CH14-DRA
12.00	12.49	18	32	32	56	68	92			
12.50	12.99	19	34	35	59	72.5	96.5			
13.00	13.49	19.5	35.5	37.5	61.5	76	100	4	8	S32-CH16-DRA
13.50	13.99	20	36.5	39.5	63.5	80	104			
14.00	14.49	21	38.5	42.5	66.5	84.5	108.5	4	8	S32-CH18-DRA
14.50	14.99	21.5	40	45	69	88.5	112.5			
15.00	15.99	22.5	41.5	47.5	71.5	92.5	116.5			
16.00	16.99	24	44.5	52.5	76.5	100.5	124.5	4	8	S32-CH20-DRA
17.00	17.99	25.5	47.5	57.5	81.5	108.5	132.5			
18.00	18.99	27.5	51	64	87	121	141	4	8	S32-CH20-DRA
19.00	19.99	29.5	54	69	92	129	149			

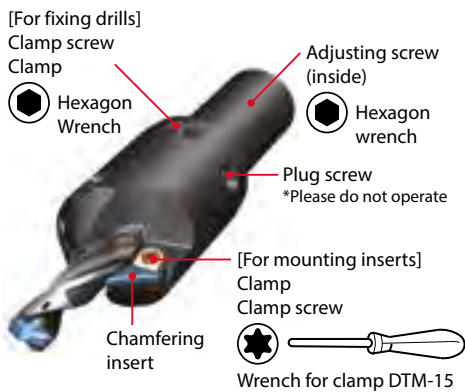

### Recommended cutting conditions (S50C)

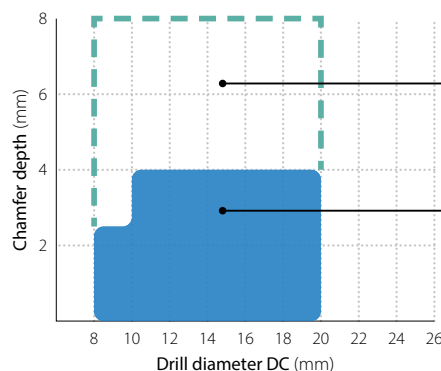

Maximum chamfer depth (Tsmax.)

\*Adjusting cutting conditions is required (Example)  
Decrease the Feed rate to half  
Decrease the cutting speed

Simultaneous drilling and chamfering is available with recommended cutting conditions for DRA (Ts)

# How to install chamfering attachment

**1** Mount DRA drill into the chamfering attachment (Fig.1)



Fig.1 Install the DRA

**2** Install an insert and tighten temporarily with clearance between the cutting edge and DRA body (Fig.2)



Fig.2 Install Inserts

**3** Adjust drilling depth by turning adjustment screw with hexagon wrench (Fig.3)

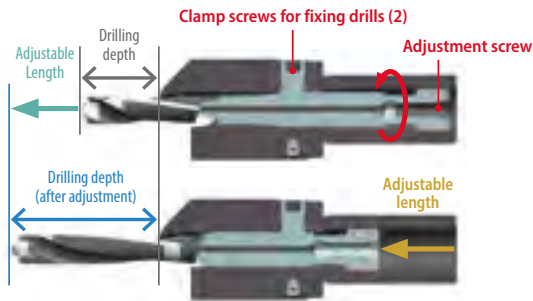

Fig.3 Adjustment of drilling depth

**4** Align the flute edge and black relief part of the drill to the position shown in Fig.4 by rotating the DRA drill (Fig.4)



Fig.4 DRA alignment

**5** Fasten the two clamp screws for DRA (See table 1. for recommended torque)

Table1. Recommended Torque

Chamfering Attachment Description	Clamp screw	
	Recommended Torque (N·m)	Width Across Flat (mm)
S20-CH10-DRA	12	4
S32-CH12-DRA	15	
S32-CH14-DRA	20	5
S32-CH16-DRA	30	6
S32-CH18-DRA	30	
S32-CH20-DRA	45	8

**6** Tighten the inserts while lightly pressing the edge of insert against the relief part (Fig.5) (Recommended torque is 3.5N·m)



Fig.5 Fully tighten

## Cautions

- Chamfering attachment is compatible with straight shank SS-DRA. It cannot be used for flanged shank SF-DRA.
- Chamfering requires two chamfering inserts. Using one insert is not recommended.
- Only fully remove Clamp screws when replacing them.

- Clamps and Clamp screws for mounting inserts need to be replaced regularly.
- Screw locking adhesive is applied to adjustment screw. The effect will eventually wear off if the screws are used for a long time. Regular replacement is recommended.
- Please do not operate the plug screws.

## DRA toolholder (with flange)



\*The photo shows a 5D holder

## Toolholder dimensions 1.5D

Description	Availability	Dimensions (mm)							Applicable insert	Spare parts							
		DC		DCON (h6)	OAL	LFS	LU	LS		DCSFMS	Clamp screw	Wrench					
		min.	max.														
SF12-DRA080M-1.5	●	7.94	8.49	12	71.2	26.2	12.8	45	16	DA0794M-... ~ DA0840M-...	HS-2524TRP						
SF12-DRA085M-1.5	●	8.50	8.99		72.5	27.5	13.5										
SF12-DRA090M-1.5	●	9.00	9.49		73.7	28.7	14.3										
SF12-DRA095M-1.5	●	9.50	9.99		75.0	30.0	15.0										
SF16-DRA100M-1.5	●	10.00	10.49	16	79.2	31.2	15.8	48	20	DA1000M-... ~ DA1040M-...	HS-2534TRP	FTP-5					
SF16-DRA105M-1.5	●	10.50	10.99		80.5	32.5	16.5										
SF16-DRA110M-1.5	●	11.00	11.49		82.7	34.7	17.3										
SF16-DRA115M-1.5	●	11.50	11.99		84.0	36.0	18.0										
SF16-DRA120M-1.5	●	12.00	12.49		85.2	37.2	18.8										
SF16-DRA125M-1.5	●	12.50	12.99		86.5	38.5	19.5										
SF16-DRA130M-1.5	●	13.00	13.49		87.7	39.7	20.3										
SF16-DRA135M-1.5	●	13.50	13.99		89.0	41.0	21.0										
SF16-DRA140M-1.5	●	14.00	14.49		90.2	42.2	21.8										
SF16-DRA145M-1.5	●	14.50	14.99		91.5	43.5	22.5										
SF20-DRA150M-1.5	●	15.00	15.99		20	97.0	47.0			24.0			50	25	DA1500M-... ~ DA1590M-...	HS-3048TRP	DTP-6
SF20-DRA160M-1.5	●	16.00	16.99			100.5	50.5			25.5							
SF20-DRA170M-1.5	●	17.00	17.99	103.0		53.0	27.0										
SF25-DRA180M-1.5	●	18.00	18.99	25	112.5	56.5	28.5	56	32	DA1800M-... ~ DA1890M-...	HS-4067TRP	DTP-7					
SF25-DRA190M-1.5	●	19.00	19.99		115.0	59.0	30.0										
SF25-DRA200M-1.5	●	20.00	20.99		117.5	61.5	31.5										
SF25-DRA210M-1.5	●	21.00	21.99		120.0	64.0	33.0										
SF25-DRA220M-1.5	●	22.00	22.99		123.5	67.5	34.5										
SF25-DRA230M-1.5	●	23.00	23.99		126.0	70.0	36.0										
SF25-DRA240M-1.5	●	24.00	24.99		128.5	72.5	37.5										
SF25-DRA250M-1.5	●	25.00	25.50		131.0	75.0	39.0										

● : Available

# DRA toolholder (with flange)

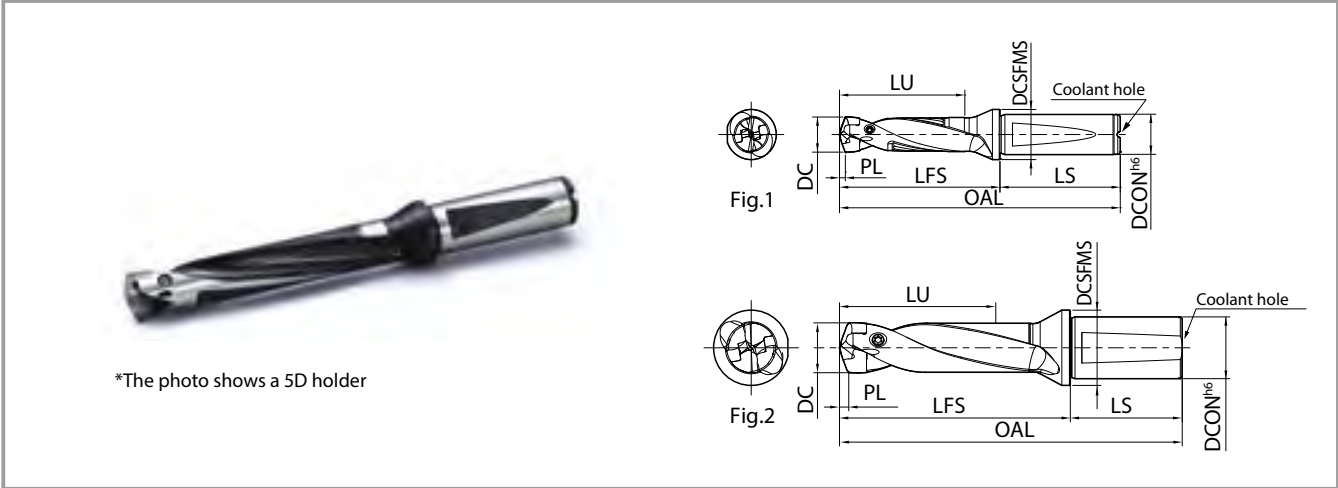

\*The photo shows a 5D holder

## Toolholder dimensions 3D

Description	Availability	Dimensions (mm)							Drawing	Applicable insert	Spare parts								
		DC		DCON (h6)	OAL	LFS	LU	LS			DCSFMS	Clamp screw	Wrench						
		min.	max.																
SF12-DRA080M-3	●	7.94	8.49	12	84	39	25.5	45	16	Fig.1	DA0794M-... ~ DA0840M-...	HS-2524TRP							
SF12-DRA085M-3	●	8.50	8.99		86	41	27.0												
SF12-DRA090M-3	●	9.00	9.49		88	43	28.5												
SF12-DRA095M-3	●	9.50	9.99		90	45	30.0												
SF16-DRA100M-3	●	10.00	10.49	16	95	47	31.5	48	20	Fig.1	DA1000M-... ~ DA1040M-...	HS-2534TRP	FTP-5						
SF16-DRA105M-3	●	10.50	10.99		97	49	33.0												
SF16-DRA110M-3	●	11.00	11.49		100	52	34.5												
SF16-DRA115M-3	●	11.50	11.99		102	54	36.0												
SF16-DRA120M-3	●	12.00	12.49		104	56	37.5												
SF16-DRA125M-3	●	12.50	12.99		106	58	39.0												
SF16-DRA130M-3	●	13.00	13.49		108	60	40.5												
SF16-DRA135M-3	●	13.50	13.99		110	62	42.0												
SF16-DRA140M-3	●	14.00	14.49		112	64	43.5												
SF16-DRA145M-3	●	14.50	14.99		114	66	45.0												
SF20-DRA150M-3	●	15.00	15.99		20	121	71				48.0			50	25	Fig.1	DA1500M-... ~ DA1590M-...	HS-3048TRP	DTP-6
SF20-DRA160M-3	●	16.00	16.99			126	76				51.0								
SF20-DRA170M-3	●	17.00	17.99	130		80	54.0												
SF25-DRA180M-3	●	18.00	18.99	25	141	85	57.0	56	32	Fig.1	DA1800M-... ~ DA1890M-...	HS-4067TRP	DTP-7						
SF25-DRA190M-3	●	19.00	19.99		145	89	60.0												
SF25-DRA200M-3	●	20.00	20.99		149	93	63.0												
SF25-DRA210M-3	●	21.00	21.99		153	97	66.0												
SF25-DRA220M-3	●	22.00	22.99		158	102	69.0												
SF25-DRA230M-3	●	23.00	23.99		162	106	72.0												
SF25-DRA240M-3	●	24.00	24.99		166	110	75.0												
SF25-DRA250M-3	●	25.00	25.50		170	114	78.0												
SF32-DRA260M-3	●	26.00	26.99		32	178	120				81.0			58	39	Fig.2	DA2600M-... ~ DA2650M-...	HS-50100TRP	DTPM-15
SF32-DRA270M-3	●	27.00	27.99			181	123				84.0								
SF32-DRA280M-3	●	28.00	28.99	185		127	87.0												
SF32-DRA290M-3	●	29.00	29.99	189		131	90.0												
SF32-DRA300M-3	●	30.00	30.99	193		135	93.0												
SF32-DRA310M-3	●	31.00	31.99	196		138	96.0												
SF32-DRA320M-3	●	32.00	33.00	200		142	99.0												

● : Available

## DRA toolholder (with flange)

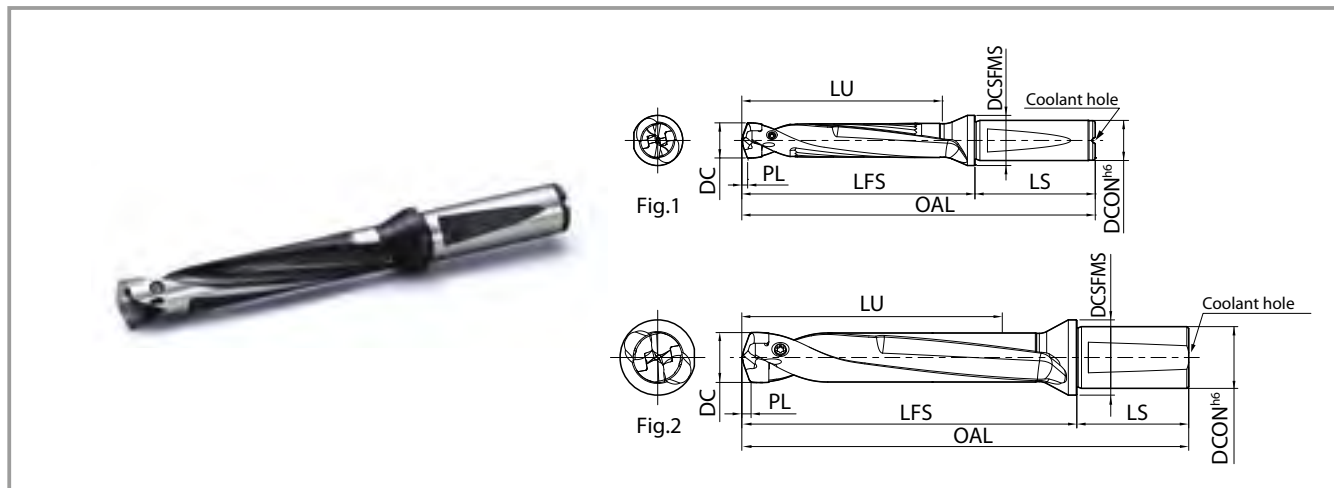

### Toolholder dimensions **5D**

Description	Availability	Dimensions (mm)								Drawing	Applicable insert	Spare parts							
		DC		DCON (h6)	OAL	LFS	LU	LS	DCSFMS			Clamp screw	Wrench						
		min.	max.																
SF12-DRA080M-5	●	7.94	8.49	12	101	56	42.5	45	16	Fig.1	DA0794M-... ~ DA0840M-...	HS-2524TRP							
SF12-DRA085M-5	●	8.50	8.99		104	59	45.0												
SF12-DRA090M-5	●	9.00	9.49		107	62	47.5												
SF12-DRA095M-5	●	9.50	9.99		110	65	50.0												
SF16-DRA100M-5	●	10.00	10.49	16	116	68	52.5	48	20	Fig.1	DA1000M-... ~ DA1040M-...	HS-2534TRP	FTP-5						
SF16-DRA105M-5	●	10.50	10.99		119	71	55.0												
SF16-DRA110M-5	●	11.00	11.49		123	75	57.5												
SF16-DRA115M-5	●	11.50	11.99		126	78	60.0												
SF16-DRA120M-5	●	12.00	12.49		129	81	62.5												
SF16-DRA125M-5	●	12.50	12.99		132	84	65.0												
SF16-DRA130M-5	●	13.00	13.49		135	87	67.5												
SF16-DRA135M-5	●	13.50	13.99		138	90	70.0												
SF16-DRA140M-5	●	14.00	14.49		141	93	72.5												
SF16-DRA145M-5	●	14.50	14.99		144	96	75.0												
SF20-DRA150M-5	●	15.00	15.99		20	153	103				80.0			50	25	Fig.1	DA1500M-... ~ DA1590M-...	HS-3048TRP	DTP-6
SF20-DRA160M-5	●	16.00	16.99			160	110				85.0								
SF20-DRA170M-5	●	17.00	17.99	166		116	90.0												
SF25-DRA180M-5	●	18.00	18.99	25	179	123	95.0	56	32	Fig.1	DA1800M-... ~ DA1890M-...	HS-4067TRP	DTP-7						
SF25-DRA190M-5	●	19.00	19.99		185	129	100.0												
SF25-DRA200M-5	●	20.00	20.99		191	135	105.0												
SF25-DRA210M-5	●	21.00	21.99		197	141	110.0												
SF25-DRA220M-5	●	22.00	22.99		204	148	115.0												
SF25-DRA230M-5	●	23.00	23.99		210	154	120.0												
SF25-DRA240M-5	●	24.00	24.99		216	160	125.0												
SF25-DRA250M-5	●	25.00	25.50		222	166	130.0												
SF32-DRA260M-5	●	26.00	26.99		32	232	174				135.0			58	39	Fig.2	DA2600M-... ~ DA2650M-...	HS-50100TRP	DTPM-15
SF32-DRA270M-5	●	27.00	27.99			237	179				140.0								
SF32-DRA280M-5	●	28.00	28.99	243		185	145.0												
SF32-DRA290M-5	●	29.00	29.99	249		191	150.0												
SF32-DRA300M-5	●	30.00	30.99	255		197	155.0												
SF32-DRA310M-5	●	31.00	31.99	260		202	160.0												
SF32-DRA320M-5	●	32.00	33.00	266	208	165.0													

● : Available

# DRA toolholder (with flange)

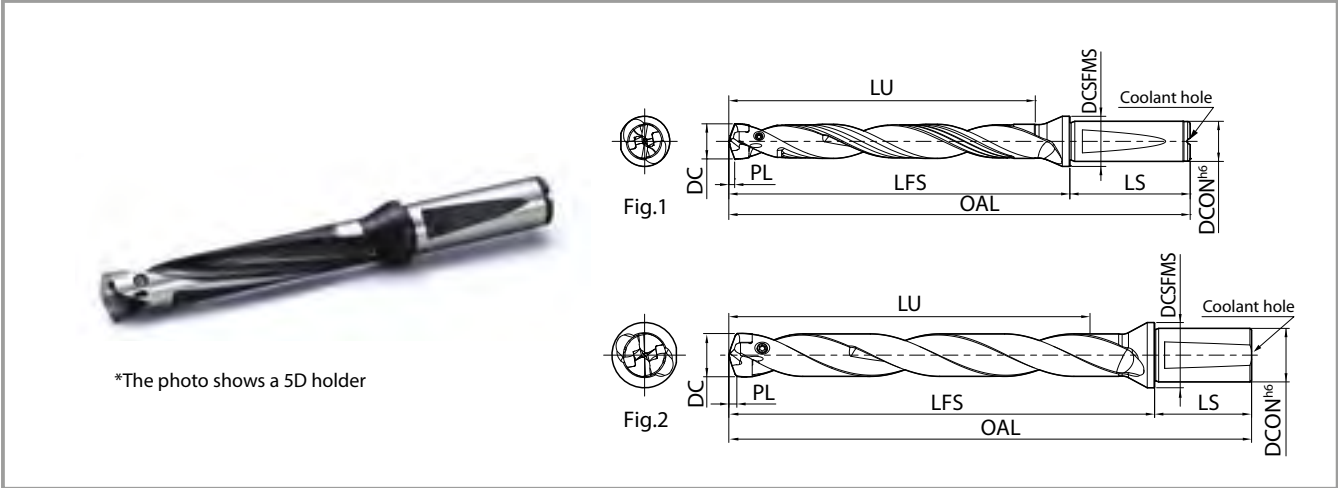

\*The photo shows a 5D holder

## Toolholder dimensions 8D

Description	Availability	Dimensions (mm)							Drawing	Applicable insert	Spare parts								
		DC		DCON (h6)	OAL	LFS	LU	LS			DCSFMS	Clamp screw	Wrench						
		min.	max.																
SF12-DRA080M-8	●	7.94	8.49	12	126	81	68.0	45	16	Fig.1	DA0794M-... ~ DA0840M-...	HS-2524TRP							
SF12-DRA085M-8	●	8.50	8.99		131	86	72.0												
SF12-DRA090M-8	●	9.00	9.49		135	90	76.0												
SF12-DRA095M-8	●	9.50	9.99		140	95	80.0												
SF16-DRA100M-8	●	10.00	10.49	16	147	99	84.0	48	20	Fig.1	DA1000M-... ~ DA1040M-...	HS-2534TRP	FTP-5						
SF16-DRA105M-8	●	10.50	10.99		152	104	88.0												
SF16-DRA110M-8	●	11.00	11.49		157	109	92.0												
SF16-DRA115M-8	●	11.50	11.99		162	114	96.0												
SF16-DRA120M-8	●	12.00	12.49		166	118	100.0												
SF16-DRA125M-8	●	12.50	12.99		171	123	104.0												
SF16-DRA130M-8	●	13.00	13.49		175	127	108.0												
SF16-DRA135M-8	●	13.50	13.99		180	132	112.0												
SF16-DRA140M-8	●	14.00	14.49		184	136	116.0												
SF16-DRA145M-8	●	14.50	14.99		189	141	120.0												
SF20-DRA150M-8	●	15.00	15.99		20	201	151				128.0	50		25	Fig.1	DA1500M-... ~ DA1590M-...	HS-3048TRP	DTP-6	
SF20-DRA160M-8	●	16.00	16.99			211	161				136.0								
SF20-DRA170M-8	●	17.00	17.99	220		170	144.0												
SF25-DRA180M-8	●	18.00	18.99	25	236	180	152.0	56	32	Fig.1	DA1800M-... ~ DA1890M-...	HS-4067TRP	DTP-7						
SF25-DRA190M-8	●	19.00	19.99		245	189	160.0												
SF25-DRA200M-8	●	20.00	20.99		254	198	168.0												
SF25-DRA210M-8	●	21.00	21.99		263	207	176.0												
SF25-DRA220M-8	●	22.00	22.99		273	217	184.0												
SF25-DRA230M-8	●	23.00	23.99		282	226	192.0												
SF25-DRA240M-8	●	24.00	24.99		291	235	200.0												
SF25-DRA250M-8	●	25.00	25.50		300	244	208.0												
SF32-DRA260M-8	●	26.00	26.99		32	313	255				216.0			58	39	Fig.2	DA2600M-... ~ DA2650M-...	HS-50100TRP	DTPM-15
SF32-DRA270M-8	●	27.00	27.99			321	263				224.0								
SF32-DRA280M-8	●	28.00	28.99	330		272	232.0												
SF32-DRA290M-8	●	29.00	29.99	339		281	240.0												
SF32-DRA300M-8	●	30.00	30.99	348		290	248.0												
SF32-DRA310M-8	●	31.00	31.99	356		298	256.0												
SF32-DRA320M-8	●	32.00	33.00	365		307	264.0												

●: Available

## DRA toolholder (with flange)

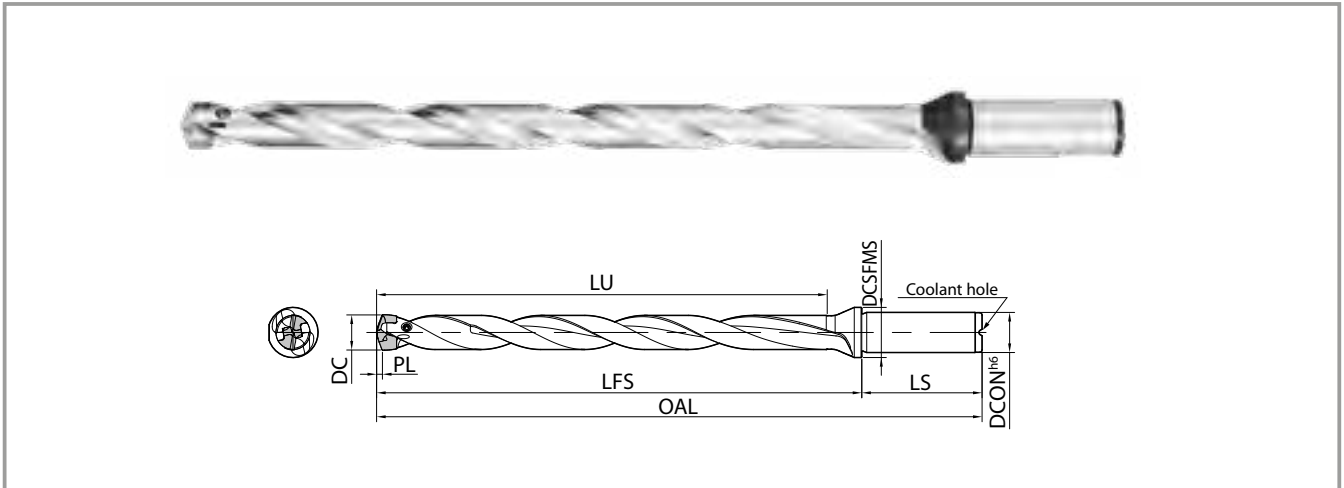

### Toolholder dimensions **12D**

Description	Availability	Dimensions (mm)							Applicable insert	Spare parts		
		DC		DCON (h6)	OAL	LFS	LU	LS		DCSFMS	Clamp screw	Wrench
		min.	max.									
SF16-DRA120M-12	●	12.00	12.49	16	216	168	150.0	48	20	DA1200-... ~ DA1240-...	HS-2534TRP	FTP-5
SF16-DRA125M-12	●	12.50	12.99		223	175	156.0			DA1250-... ~ DA1290-...		
SF16-DRA130M-12	●	13.00	13.49		229	181	162.0			DA1300-... ~ DA1340-...		
SF16-DRA135M-12	●	13.50	13.99		236	188	168.0			DA1350-... ~ DA1390-...		
SF16-DRA140M-12	●	14.00	14.49		242	194	174.0			DA1400-... ~ DA1440-...		
SF16-DRA145M-12	●	14.50	14.99		249	201	180.0			DA1450-... ~ DA1490-...		
SF20-DRA150M-12	●	15.00	15.99	20	265	215	192.0	50	25	DA1500-... ~ DA1590-...	HS-3048TRP	DTP-6
SF20-DRA160M-12	●	16.00	16.99		279	229	204.0			DA1600-... ~ DA1690-...		
SF20-DRA170M-12	●	17.00	17.99		292	242	216.0			DA1700-... ~ DA1790-...		
SF25-DRA180M-12	●	18.00	18.99	25	312	256	228.0	56	32	DA1800-... ~ DA1890-...	HS-4067TRP	DTP-7
SF25-DRA190M-12	●	19.00	19.99		325	269	240.0			DA1900-... ~ DA1990-...		
SF25-DRA200M-12	●	20.00	20.99		338	282	252.0			DA2000-... ~ DA2090-...		
SF25-DRA210M-12	●	21.00	21.99		351	295	264.0			DA2100-... ~ DA2150-...		
SF25-DRA220M-12	●	22.00	22.99		365	309	276.0			DA2200-... ~ DA2250-...		
SF25-DRA230M-12	●	23.00	23.99		378	322	288.0			DA2300-... ~ DA2350-...		
SF25-DRA240M-12	●	24.00	24.99		391	335	300.0			DA2400-... ~ DA2450-...		
SF25-DRA250M-12	●	25.00	25.50		404	348	312.0			DA2500-... ~ DA2550-...		

● : Available

## Spare parts

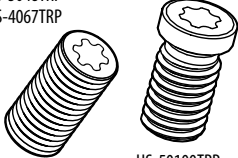
Clamp screw	Description
HS-2524TRP	HS-2524TRP
HS-2534TRP	HS-2534TRP
HS-3048TRP	HS-3048TRP
HS-4067TRP	HS-4067TRP
 HS-50100TRP	HS-50100TRP

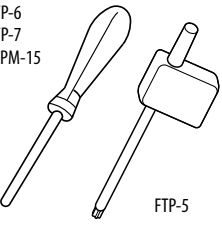
Wrench	Description	Torque (N · m)
 DTP-6 DTP-7 DTPM-15	FTP-5	0.5
	DTP-6	0.8
	DTP-7	1.2
	DTPM-15	3.5

# Recommended cutting conditions ★ 1st recommendation ☆ 2nd recommendation

## GM / HQP / HQS type inserts

Workpiece	Insert	Recommended grade/ Vc (m/min)		Spindle revolution (min <sup>-1</sup> )	Cutting dia. DC (mm)				Notes
		PR1535	PR1525		ø8	ø11	ø14	ø18	
Low carbon steel	GM	★ 100 – 180	☆ 100 – 180	Spindle revolution (min <sup>-1</sup> )	3,980 - 7,160	2,890 - 5,210	2,270 - 4,090	1,770 - 3,180	Wet type ( See page 25 )
				Feed rate (mm/rev)	0.12 - 0.24	0.12 - 0.31	0.16 - 0.36	0.16 - 0.4	
	HQP			Spindle revolution (min <sup>-1</sup> )	3,180 - 7,160	2,310 - 5,210	1,810 - 4,090	1,410 - 3,180	
				Feed rate (mm/rev)	0.12 - 0.24	0.12 - 0.28	0.16 - 0.32	0.16 - 0.36	
Carbon steel	GM	★ 100 – 150	☆ 100 – 150	Spindle revolution (min <sup>-1</sup> )	3,980 - 5,970	2,890 - 4,340	2,270 - 3,410	1,770 - 2,650	
				Feed rate (mm/rev)	0.12 - 0.24	0.12 - 0.31	0.16 - 0.36	0.16 - 0.4	
	HQP			Spindle revolution (min <sup>-1</sup> )	3,180 - 7,160	2,310 - 5,210	1,810 - 4,090	1,410 - 3,180	
				Feed rate (mm/rev)	0.12 - 0.24	0.12 - 0.28	0.16 - 0.32	0.16 - 0.36	
Alloy steel	GM	★ 70 – 120	☆ 70 – 120	Spindle revolution (min <sup>-1</sup> )	2,790 - 4,780	2,030 - 3,470	1,590 - 2,730	1,240 - 2,120	
				Feed rate (mm/rev)	0.12 - 0.24	0.12 - 0.31	0.16 - 0.36	0.16 - 0.4	
	HQP			Spindle revolution (min <sup>-1</sup> )	2,790 - 4,780	2,030 - 3,470	1,590 - 2,730	1,240 - 2,120	
				Feed rate (mm/rev)	0.12 - 0.24	0.12 - 0.28	0.16 - 0.32	0.16 - 0.36	
Mold steel	GM	★ 50 – 90	☆ 50 – 90	Spindle revolution (min <sup>-1</sup> )	1,990 - 3,580	1,450 - 2,600	1,140 - 2,050	880 - 1,590	
				Feed rate (mm/rev)	0.08 - 0.17	0.08 - 0.22	0.11 - 0.25	0.11 - 0.28	
	HQP			Spindle revolution (min <sup>-1</sup> )	1,990 - 3,580	1,450 - 2,600	1,140 - 2,050	880 - 1,590	
				Feed rate (mm/rev)	0.08 - 0.17	0.08 - 0.2	0.11 - 0.23	0.11 - 0.26	
Stainless steel	GM	★ 40 – 70	☆ 40 – 70	Spindle revolution (min <sup>-1</sup> )	1,590 - 2,790	1,160 - 2,030	910 - 1,590	710 - 1,240	
				Feed rate (mm/rev)	0.1 - 0.24	0.1 - 0.24	0.12 - 0.3	0.15 - 0.3	
	HQS			Spindle revolution (min <sup>-1</sup> )	1,590 - 1,990	1,160 - 1,450	910 - 1,140	710 - 880	
				Feed rate (mm/rev)	0.08 - 0.12	0.10 - 0.15	0.10 - 0.15	0.12 - 0.18	
Heat-resistant alloy	HQS	★ 15 – 20		Spindle revolution (min <sup>-1</sup> )	600 - 800	430 - 580	340 - 450	270 - 350	
				Feed rate (mm/rev)	0.08 - 0.12	0.08 - 0.15	0.10 - 0.15	0.12 - 0.18	
	HQS			Spindle revolution (min <sup>-1</sup> )	1,190 - 1,590	870 - 1,160	680 - 910	530 - 710	
				Feed rate (mm/rev)	0.08 - 0.12	0.08 - 0.15	0.10 - 0.15	0.12 - 0.18	
Titanium alloy	HQS	★ 30 – 40		Spindle revolution (min <sup>-1</sup> )	1,190 - 1,590	870 - 1,160	680 - 910	530 - 710	
				Feed rate (mm/rev)	0.08 - 0.12	0.08 - 0.15	0.10 - 0.15	0.12 - 0.18	
	HQS			Spindle revolution (min <sup>-1</sup> )	1,190 - 1,590	870 - 1,160	680 - 910	530 - 710	
				Feed rate (mm/rev)	0.08 - 0.12	0.08 - 0.15	0.10 - 0.15	0.12 - 0.18	
Gray cast iron	GM	☆ 90 – 170	★ 90 – 170	Spindle revolution (min <sup>-1</sup> )	3,580 - 6,760	2,600 - 4,920	2,050 - 3,870	1,590 - 3,010	
				Feed rate (mm/rev)	0.14 - 0.29	0.14 - 0.37	0.19 - 0.43	0.19 - 0.45	
Nodular cast iron	GM	☆ 40 – 120	★ 40 – 120	Spindle revolution (min <sup>-1</sup> )	1,590 - 4,780	1,160 - 3,470	910 - 2,730	710 - 2,120	
				Feed rate (mm/rev)	0.12 - 0.24	0.12 - 0.31	0.16 - 0.36	0.16 - 0.4	

Workpiece	Insert	Recommended grade/ Vc (m/min)		Spindle revolution (min <sup>-1</sup> )	Cutting dia. DC (mm)				Notes
		PR1535	PR1525		ø22	ø25	ø29	ø33	
Low carbon steel	GM	★ 100 – 180	☆ 100 – 180	Spindle revolution (min <sup>-1</sup> )	1,450 - 2,600	1,270 - 2,290	1,100 - 1,980	970 - 1,740	Wet type ( See page 25 )
				Feed rate (mm/rev)	0.2 - 0.45	0.2 - 0.45	0.2 - 0.45	0.2 - 0.45	
Carbon steel	GM	★ 100 – 150	☆ 100 – 150	Spindle revolution (min <sup>-1</sup> )	1,450 - 2,170	1,270 - 1,910	1,100 - 1,650	970 - 1,450	
				Feed rate (mm/rev)	0.2 - 0.45	0.2 - 0.45	0.2 - 0.45	0.2 - 0.45	
Alloy steel	GM	★ 70 – 120	☆ 70 – 120	Spindle revolution (min <sup>-1</sup> )	1,010 - 1,740	890 - 1,530	770 - 1,320	680 - 1,160	
				Feed rate (mm/rev)	0.2 - 0.45	0.2 - 0.45	0.2 - 0.45	0.2 - 0.45	
Mold steel	GM	★ 50 – 90	☆ 50 – 90	Spindle revolution (min <sup>-1</sup> )	720 - 1,300	640 - 1,150	550 - 990	490 - 870	
				Feed rate (mm/rev)	0.14 - 0.32	0.14 - 0.32	0.14 - 0.32	0.14 - 0.32	
Stainless steel	GM	★ 40 – 70	☆ 40 – 70	Spindle revolution (min <sup>-1</sup> )	580 - 1,010	510 - 890	440 - 770	390 - 680	
				Feed rate (mm/rev)	0.15 - 0.3	0.15 - 0.35	0.15 - 0.35	0.15 - 0.35	
Gray cast iron	GM	☆ 90 – 170	★ 90 – 170	Spindle revolution (min <sup>-1</sup> )	1,300 - 2,460	1,150 - 2,170	990 - 1,870	870 - 1,640	
				Feed rate (mm/rev)	0.24 - 0.45	0.24 - 0.45	0.24 - 0.45	0.24 - 0.45	
Nodular cast iron	GM	☆ 40 – 120	★ 40 – 120	Spindle revolution (min <sup>-1</sup> )	580 - 1,740	510 - 1,530	440 - 1,320	390 - 1,160	
				Feed rate (mm/rev)	0.2 - 0.45	0.2 - 0.45	0.2 - 0.45	0.2 - 0.45	

Note: Recommended cutting conditions above is for 1.5D/3D type. As drilling depth increases (1.5D/3D → 5D → 8D → 12D), Feed rates should be reduced.

Recommended feed rate (GM): 1.5D/3D type = 100%, 5D/8D type = 80% or less, 12D type = 70% or less.

Recommended feed rate (HQP/HQS): 1.5D/3D type = 100%, 5D type = 80% or less, 8D type = 70% or less, 12D type = 70% or less.



# Recommended cutting conditions ★ 1st recommendation ☆ 2nd recommendation

## FTP - counterboring

Workpiece	Recommended Grade / Vc (m/min)		Spindle revolution (min <sup>-1</sup> ) Feed rate (mm/rev)	Cutting Dia. DC (mm)						Notes
	PR1535	PR1525		ø8	ø11	ø14	ø18	ø22	ø25	
Low carbon steel	★ 80 – 150	☆ 80 – 150	Spindle revolution (min <sup>-1</sup> )	3,150 – 6,000	2,300 – 4,350	1,800 – 3,400	1,400 – 2,650	1,150 – 2,200	1,000 – 1,900	Wet type ( See page 25 )
			Feed rate (mm/rev)	0.12 – 0.24	0.12 – 0.31	0.16 – 0.36	0.16 – 0.40	0.20 – 0.45	0.20 – 0.45	
Carbon steel	★ 80 – 120	☆ 80 – 120	Spindle revolution (min <sup>-1</sup> )	3,150 – 4,750	2,300 – 3,450	1,800 – 2,700	1,400 – 2,100	1,150 – 1,750	1,000 – 1,500	
			Feed rate (mm/rev)	0.12 – 0.24	0.12 – 0.31	0.16 – 0.36	0.16 – 0.40	0.20 – 0.45	0.20 – 0.45	
Alloy steel	★ 70 – 120	☆ 70 – 120	Spindle revolution (min <sup>-1</sup> )	2,800 – 4,750	2,000 – 3,450	1,600 – 2,700	1,250 – 2,100	1,000 – 1,750	900 – 1,500	
			Feed rate (mm/rev)	0.12 – 0.24	0.12 – 0.31	0.16 – 0.36	0.16 – 0.40	0.20 – 0.40	0.20 – 0.45	
Mold steel	★ 40 – 70	☆ 40 – 70	Spindle revolution (min <sup>-1</sup> )	1,600 – 2,800	1,150 – 2,000	900 – 1,600	700 – 1,250	600 – 1,000	500 – 900	
			Feed rate (mm/rev)	0.08 – 0.17	0.08 – 0.22	0.11 – 0.25	0.11 – 0.28	0.14 – 0.30	0.14 – 0.32	
Stainless steel	★ 40 – 70	☆ 40 – 70	Spindle revolution (min <sup>-1</sup> )	1,600 – 2,800	1,150 – 2,000	900 – 1,600	700 – 1,250	600 – 1,000	500 – 900	
			Feed rate (mm/rev)	0.10 – 0.20	0.10 – 0.20	0.10 – 0.24	0.15 – 0.24	0.15 – 0.24	0.15 – 0.28	
				Feed rate 0.15mm/rev or less is recommended until drilling depth reaches 0.5 x DC mm.						
Gray cast iron	☆ 70 – 140	★ 70 – 140	Spindle revolution (min <sup>-1</sup> )	2,800 – 5,600	2,000 – 4,050	1,600 – 3,200	1,250 – 2,500	1,000 – 2,000	900 – 1,800	
			Feed rate (mm/rev)	0.14 – 0.29	0.14 – 0.37	0.19 – 0.43	0.19 – 0.45	0.24 – 0.45	0.24 – 0.45	
Nodular cast iron	☆ 40 – 100	★ 40 – 100	Spindle revolution (min <sup>-1</sup> )	1,600 – 4,000	1,150 – 2,900	900 – 2,750	700 – 1,750	600 – 1,450	500 – 1,250	
			Feed rate (mm/rev)	0.12 – 0.24	0.12 – 0.31	0.16 – 0.36	0.16 – 0.40	0.2 – 0.45	0.2 – 0.45	

Notes: The recommended cutting conditions are for drilling on plain surface.  
 The conditions for drilling on slant hole shows the depth from the top of workpiece.  
 Set the Feed rate under 50% when inclination angle is under 30°. Set the feed rate under 30% when inclination angle is over 30°. Traversing is not recommended.  
 Applicable to 1.5D, 3D, 5D, 8D and 12D holders, Prepared hole (0.5 x DC) is needed when using 8D/12D holder.  
 Recommended feed rate: 1.5D/3D type = 100%, 5D/8D type = 80% or less, 12D type = 70% or less.  
 Recommended cutting speed: 8D type = 80% or less, 12D type = 70% or less.

### Low carbon steel / Carbon steel / Alloy steel

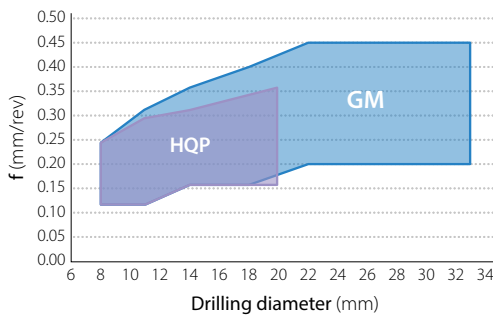

### Mold steel

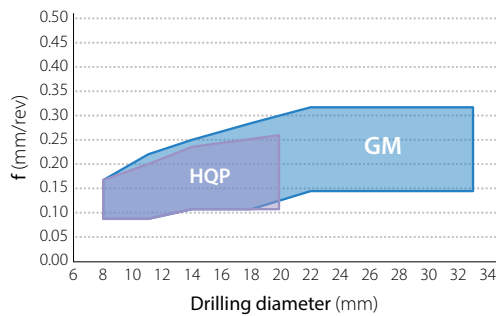

### Stainless steel

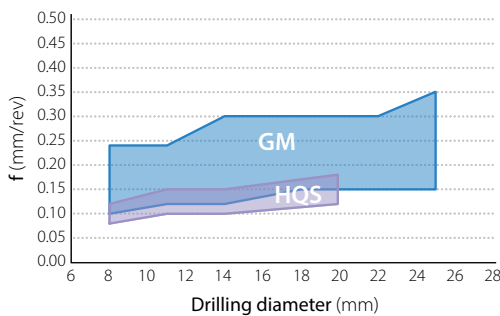

### Heat-resistant alloy / Titanium alloy

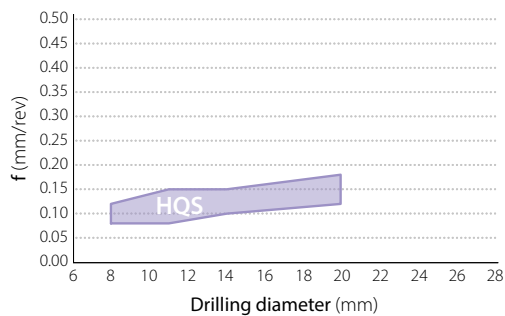

**Coolant** \*Dry cutting is not recommended

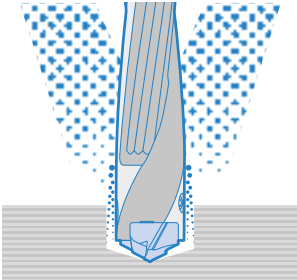
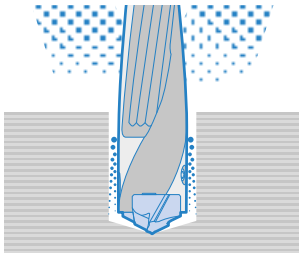
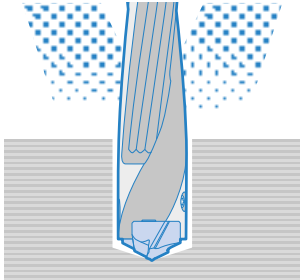
1st recommendation	The combination of internal and external coolant is recommended	In case of external coolant
<p><b>Internal coolant</b></p> <p>Drilling depth is less than 1DC</p> 	<p>Stainless steel, heat-resistant alloys, titanium alloys machining and high feed machining</p> 	<p>Lathe: Within 3DC Vertical M/C: Within 1.5DC</p> 

**How to attach inserts**

- 1 Install insert onto the toolholder in the right direction
- 2 Tighten clamp screw to fix the insert  
(Torque: see page 14 and 22)

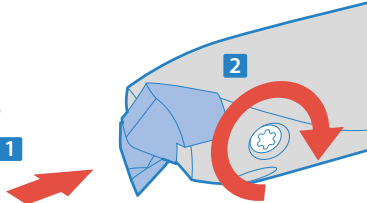

Be careful of the insert direction

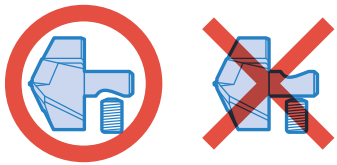

\*1 Remove dust on insert pocket using air blow for every replacement.  
\*2 Make sure that the locating surfaces of the insert closely contacts the toolholder.

**Core deviation / Alignment cautions**

If drill is stationary

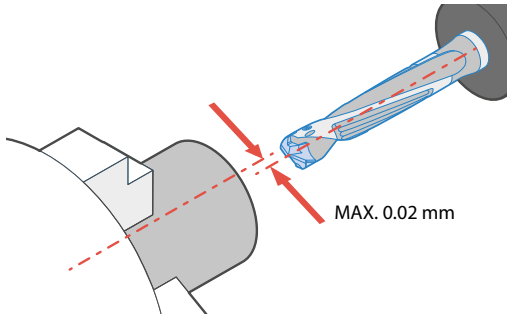

MAX. 0.02 mm

DRA works with both boring sleeve and collet-chuck. Center line deviation should be less than 0.02 mm between workpiece and drill.

If drill is rotating

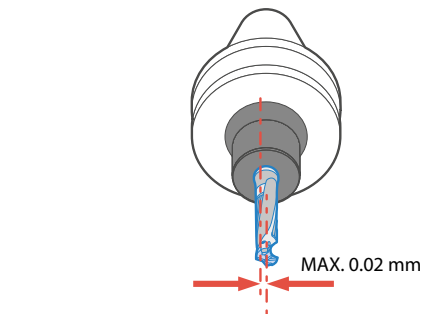

MAX. 0.02 mm

Do not use any arbor whose attachment surface is deformed. Center deviation must be less than 0.02 mm.

**Caution for installation on machining center**

How to install DRA

- 1st recommendation
- Hydro-chuck, Power-chuck, Collet-chuck

Install DRA into these chucks

- Hydro-chuck
- Power-chuck
- Collet-chuck

- 2nd recommendation
- Side lock arbor

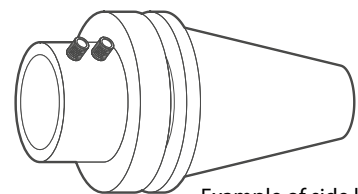

Example of side lock arbor

## Other cautions





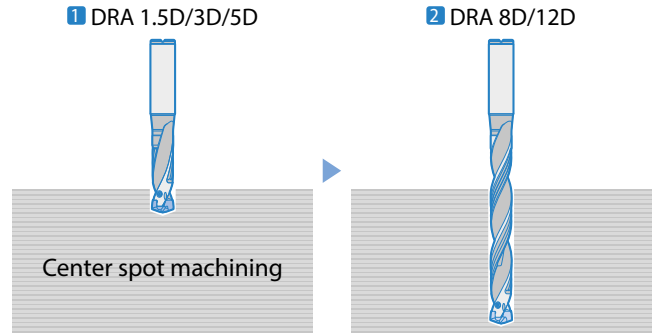

### Cautions for machining with 8D/12D holder

#### Recommended machining

- 1 Make a center spot using DRA 1.5D/3D/5D type  
(Center spot should be at least half of cutting diameter)
- 2 Then drill the hole using DRA (8D/12D type)



### Applicable workpiece (for GM, HQP, HQS)

Application	Workpiece shape	Caution for machining
Plain surface		<ol style="list-style-type: none"> <li>1. When machining stainless steel, for hole depths of up to 0.5DC, keep Feed rate at less than 0.15mm/rev.</li> <li>2. Internal coolant is recommended for smooth chip removal. For stainless steel, the combination of internal and external coolant is recommended.</li> </ol>
Stacked plates		<ol style="list-style-type: none"> <li>1. Fix stacked plates securely to ensure they do not slip while machining.</li> </ol>
Concave surface		<ol style="list-style-type: none"> <li>1. When machining concave holes, set the Feed rate at less than half of recommended feed for continuous hole machining.</li> <li>2. Utilize a pecking cycle if chips are not broken short at the inlet.</li> </ol>
Pipe material		<ol style="list-style-type: none"> <li>1. Hole machining above the centerline of the pipe is possible.</li> <li>2. Do not machine on curved surface areas.</li> </ol> <div style="display: flex; justify-content: space-around; align-items: center;"> <div style="text-align: center;"> <p><b>Good</b></p>  <p>Center portion machining</p> </div> <div style="text-align: center;"> <p><b>Bad</b></p>  <p>Curved surface portion machining</p> </div> </div>

\*See page 11 for FTP

### Non-recommended workpieces (for GM, HQP, HQS)

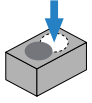
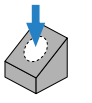
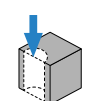
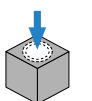
Application	Workpiece shape	Application	Workpiece shape
Hole expansion		Slant surface	
Half cylindrical		Cored hole	

\*See page 11 for FTP

# KDA

Applicable to a wide range of machining applications

## Type N

General purpose design without coolant holes.  
Economical style for machining with external coolant.

## Type C

Coolant-through design  
Provides higher efficiency and stable machining  
with stainless steel etc.



# GammaDrill™

High efficient drilling  
in aluminium alloys

## Standard

General purpose design with internal coolant.

## Customized

Get your special designed GammaDrill™ solution  
with optional diameters, step and coolant holes\*.

